

# HOLLOW METAL MANUAL

NAAMM STANDARD

# HMMA 850-14

NAAMM 09 14  METAL DOORS & FRAMES  
Fire & Smoke Control Rated

# FIRE-PROTECTION AND SMOKE CONTROL RATED HOLLOW METAL DOOR AND FRAME PRODUCTS

FOURTH EDITION

NAAMM 09 14  METAL DOORS & FRAMES  
Fire & Smoke Control Rated



## DISCLAIMER

This Manual was developed by representative members of and approved by the Hollow Metal Manufacturers Association (HMMA) Division of the National Association of Architectural Metal Manufacturers (NAAMM) to provide their opinion and guidance on the specification and use of fire-protection and smoke control rated hollow metal doors and frame product. This Manual contains advisory information only and is published as a public service by NAAMM. NAAMM disclaims all liability of any kind for the use, application or adaptation of material published in this Manual.

*Current information on all NAAMM Standards is available by calling, writing or visiting the website of the National Association of Architectural Metal Manufacturers, [www.naamm.org](http://www.naamm.org).*

**National Association of Architectural Metal Manufacturers**  
800 Roosevelt Road, Building C, Suite 312, Glen Ellyn, IL 60137  
Tel 1-630-942-6591 • Fax 1-630-790-395  
Email: [info@naamm.org](mailto:info@naamm.org)  
Website: [www.naamm.org](http://www.naamm.org)

# CONTENTS

---

- GENERAL INFORMATION ..... Section 1**
  - Protection of Wall Openings
  - Basic Requirements
  - Classification of Fire Doors and Frame Product
  - Fire Tests
  - Smoke Control Rated Assemblies
  - Safety Rated Glazing Materials
  - Listing, Labeling and Certification Organizations
  - Representative Labels for Hollow Metal Fire Doors and Frame Product
  - Field Labeling and Modifications
  - Design Limitations
  - Local Regulations; The Architect's Responsibilities
  - Guidelines for Proper Usage
  - Ranges of Types and Sizes Available
  - Representative Types of Hollow Metal Fire Doors
  - Labeled Glazing Materials for Hollow Metal Fire Doors
  - Representative Types of Fire Door Frames
  - Labeled Materials for Transom, Sidelight and Window Assembly Openings
  
- HARDWARE FOR SWINGING HOLLOW METAL FIRE DOORS ..... Section 2**
  - General Hardware Requirements
  - Builders Hardware for Singles and Pairs of Doors
  - Builders Hardware for Pairs of Doors
  - Hardware Code Summary
  
- HOLLOW METAL FIRE DOORS AND FRAME PRODUCT ..... Section 3**
  - Summary - Hollow Metal Fire Doors
  - Summary - Fire Door Frame Product
  - Basic Hollow Metal Fire Doors
  - Pairs of Hollow Metal Fire Doors in a Means of Egress
  - Temperature-Rise Rated Hollow Metal Fire Doors
  - Double Egress Hollow Metal Fire Doors and Frames
  - Stainless Steel Fire Doors
  - Dutch Hollow Metal Fire Doors
  - Louvered Hollow Metal Fire Doors
  - Three-Sided Door Frames
  - Multiple Opening Frames
  - Frames with 1¾" (44 mm) Transom Panels Without Transom Mullions
  - Transom Frames with 1¾" (44 mm) Transom Panels and Transom Mullions
  - Transom Frames with Transom Panels and Transom Mullions
  - Transom Frames - Glazed
  - Multiple Opening Transom Frames - Glazed or Paneled
  - Sidelight and Window Frames - Glazed or Paneled
  - Application Specific Fire Door and Frame Assemblies
  - Profiles for Fire Door Frame Product
  - Anchors for Fire Door Frame Product
  - Other Design Limitations for Fire Door and Frame Product
  
- REFERENCE AND SUPPORT MATERIALS ..... Section 4**
  - Footnote References
  - Reference Standards
  - US and Corresponding Canadian Standards
  - Fire Door Labels for US and/or Canadian Code Compliance
  - Code or Standard Defined Terms
  - Abbreviations

# FOREWORD

---

NAAMM published the first edition of this manual in 1974 entitled, "Fire-Rated Custom Metal Doors and Frames". Much progress has been made in the development of *hollow metal door and frame assemblies* capable of providing *fire-protection* in wall openings since the publication of the first edition. The second and third editions were published in 1983 and 2000 respectively.

This fourth edition, re-titled "Fire-Protection and Smoke Control Rated Hollow Metal Door and Frame Products", presents data on current practices within the industry with emphasis on the requirements of the International Building Code (IBC) in the United States. The information presented is based on the [2012 IBC](#), [NFPA 80-2010](#), the Reference *Standards* included on Page [4-3](#), UL LLC (Underwriters Laboratories - UL) (UL; [Doors - Cat. GSZN](#), [Frames - Cat. GVTV](#)), Warnock Hersey Inc./Intertek Testing Services ([WHI/ITS](#)) and Factory Mutual ([FM > Building Materials > FM Approval Class 4100](#)) *listings* of HMMA member manufacturers in effect on the publication date of this manual. Except for reference materials provided in [Section 4](#) this manual does not address the specific requirements of any other current or legacy national or model code.

Within this document references to the 2012 IBC and NFPA 80-2010 are footnoted as [x]. The footnotes for Chapter-Section Numbers and the Title/Topic names are included on Page [4-2](#). Where an NFPA 80 reference indicates Annex information, it too should be reviewed. Terms in *italics* indicate they are 'defined' in ANSI/NAAMM [HMMA 801](#), the IBC and/or NFPA 80 and used in that context. A list of these terms is included on Page [4-5](#).

Fire testing, *listing*, *labeling* and certification services are thoroughly covered. The section on hardware and its proper use with *fire-protection rated* doors has been considerably expanded. The section on *fire-protection rated* products describes *classified* doors and frames currently available from NAAMM/HMMA [member companies](#) together with requirements relating to *glazing materials* and their application.

To assist in quickly locating specific information this Adobe Pdf document contains internal and external hyper-linking. Clicking text high-lighted in [blue](#) will present the page on which it appears the website or document referenced.

Certain web-based hyper-links may require 'registration' by the user. Others, particularly those for test standards, are copyright protected and therefore free and public access to the full standard is not available. In these cases, when available, we have included links to the "Scope" portion of the document provided by most Standards Writing Organizations (SWO).

To ensure the most current information possible is presented, as member manufacturer's fire-protection rated products evolve, individual pages will be up-dated. Revised pages will be annotated with the effective month/year revision date in the bottom right corner.

NAAMM/HMMA is actively involved in the development of national and international codes, fire, life safety and product performance *standards*. NAAMM/HMMA provides its recognized expertise and fosters liaisons through various working committees of ASTM, ANSI, UL, WHI/ITS, NFPA, BHMA, AIA, DHI and other industry related organizations.

Values stated in this manual are presented in inch-pound units and their corresponding metric values are in parenthesis for reference purposes only.

It is believed that this fourth edition will prove to be an invaluable reference document for those responsible for specifying *fire-protection rated* products. NAAMM welcomes comments regarding the content of the manual and appreciates suggestions for improvement of future editions. Contact NAAMM-HMMA at 1-630-942-6591 or by email; [info@naamm.org](mailto:info@naamm.org).

## GENERAL INFORMATION

## CONTENTS

|  |      |
|--|------|
| Protection of Wall Openings .....  | 1-2  |
| Basic Requirements .....   | 1-3  |
| Classification of Fire Doors<br>and Frame Product .....                        | 1-4  |
| Fire Tests .....   | 1-5  |
| Smoke Control Rated Assemblies .....   | 1-6  |
| Safety Rated Glazing Materials .....   | 1-8  |
| Listing, Labeling and<br>Certification Organizations .....                     | 1-8  |
| Representative Labels for Hollow Metal<br>Fire Doors and Frame Product .....   | 1-10 |
| Field Labeling and Field Modifications .....                                   | 1-11 |
| Design Limitations .....   | 1-11 |
| Local Regulations;<br>The Architect's Responsibilities .....                   | 1-12 |
| Guidelines for Proper Usage .....  | 1-13 |
| Range of Types and Sizes Available .....                                       | 1-13 |
| Representative Types of<br>Hollow Metal Fire Doors .....                       | 1-14 |
| Labeled Glazing Materials for<br>Hollow Metal Fire Doors .....                 | 1-14 |
| Representative Types of<br>Fire Door Frames .....                              | 1-15 |
| Labeled Materials for Transom, Sidelight<br>and Window Assembly Openings ..... | 1-15 |

## Protection of Wall Openings

*Hollow metal door and frame products* play a crucial role in providing the fire and life safety protection required in any building. There are however a number of variations in their designs and performance levels. Therefore, in order to make the proper selection, it is essential that specifiers have adequate information on the different *fire door and frame products* available.

The International Building Code (IBC), published every three years by the International Code Council (ICC), is the defacto model code for the United States. Five editions (2000 to 2012, with or without amendments) have now been adopted in all 50 States and the District of Columbia. Each edition presents slightly differing requirements relating to building, fire and life safety. This document must therefore be read in conjunction with the specific edition in force for the project jurisdiction. Unless specifically indicated otherwise, code requirements take precedence over information presented in this document.

Fire-rating requirements are established by the governing building code and will depend on the uses or occupancy groups within the building (i.e.; the specific locations in the building and the potential fire hazards of particular areas). *Hollow metal fire door and frame products* achieve ratings ranging from 1/3 hour to a maximum of 3 hours which are determined by the exposure limitations of the assembly itself.

The basic requirements and limitations affecting the installation and maintenance of *fire door assemblies* are defined in the National Fire Protection Association, "Standard for Fire Doors and Other Opening Protectives", ANSI/NFPA 80, which is referenced in the IBC <sup>[1]</sup>.

This manual provides information needed to select and specify swinging *fire door and window assemblies* to provide the level of *fire-protection* required.

For fire and life safety the IBC utilizes two distinct protection concepts; 'active' and 'passive'. 'Active protection' encompasses products or systems that initiate their 'operational mode' after the initial stages of a fire event, once either manually or *automatically* activated. They require inherent thresholds of pre-determined temperature rise, rate of temperature rise or products of combustion to 'trigger' the system, or human intervention. The most commonly used active systems are fire alarms and sprinklers.

'Passive protection' includes components, assemblies and systems providing *fire-protection* without any intervention (manual or *automatic*), have no 'activation trigger thresholds' and function before and during a fire event. *Fire door assemblies* and fire-rated walls are two primary examples.

The IBC defines the minimum standard for fire, life, building safety and construction. It however contains provisions which allow the reduction or removal of passive protection requirements based solely on the use of *automatic* sprinklers.

These provisions do not address the fundamental purpose of compartmentalization and pro-active, preventative measures available to protect human life. It provides for sprinkler protected areas without fire-rated separations or *fire door assemblies*.

Without the inherent performance characteristics of *hollow metal fire door and frame products*, their *self-closing* and *self-latching* requirements, the delay of a fire alarm due to human factors, activation thresholds and/or sprinkler system response times, presents a deadly, real-life opportunity for the spread fire and toxic combustibles to adjacent areas.

As well the IBC contains provision for what have been termed "sprinkler-protected windows" or "window sprinklers". ANSI/UL 9 or ANSI/NFPA 257 testing for *fire-protection rated window assemblies* is not required. The "*listings*" cover only the sprinkler. Limitations with respect to the framing are simply "non-combustible" with *glazing materials* indicated "as listed". Non-combustible does not encompass structurally appropriate at the temperature levels used in *fire-protection rated window assembly* fire tests. There are no requirements for *fire-protection rated window assemblies* or *glazing materials* in the *listings* or code for these windows.

HMMA firmly believes fire and life safety should be based on a fully balanced approach. This Association supports the appropriate use of active protection systems for their detection, suppression and extinguishing characteristics during fire events. However, issues such as seismic, severe wind storm or other natural disasters, monumental or localized power failures, system malfunctions, human error and the complexities of today's construction methods and materials necessitates passive *fire-protection* as the first line of defense.

Therefore, it is the recommendation of HMMA and its member manufacturers that *fire door and window assemblies* be specified irrespective of any code provisions for their reduction or elimination with the use of sprinklers.

As used in this document, the IBC and NFPA 80, the term *fire door assembly* refers to any combination of (swinging *hollow metal*) door, frame product, hardware and other accessories which together provide a specific degree of *fire-protection* to an opening. In addition, HMMA uses the term "frame products" to describe as a group; *frames, transom frames, sidelight and window assemblies*.

**Section 3** describes typical swinging *hollow metal fire doors and frame products* and the following application specific *hollow metal fire door assemblies*:

- Sound Control
- Commercial Security
- Detention Security
- Bullet Resistant
- Radiation Shielding

HMMA member manufacturers are continually improving existing products and introducing new ones to meet the evolving needs of codes, regulations and market demands. Contact the NAAMM office at (630) 942-6591, e-mail at info@naamm.org or any [member manufacturer](#) for assistance if the design criteria desired is beyond the scope of the products described in this manual.

**Basic Requirements**

*Fire-protection* of a wall opening requires a complete *fire door assembly*. The Architect must be certain that all components, which include the door, frame product, *glazing*, hardware and installation, have been proven to be capable of providing the level of *fire-protection* required by the governing code and are properly *labeled* per NFPA 80 [50]. Most typical combinations of these *labeled* components are presented in this manual.

*Labels*, certification or *listing marks* provide evidence that each component has been *listed* by a nationally recognized certification organization having a factory inspection service and has been constructed as detailed in the Follow-Up Service Procedures or Factory Inspection Manuals issued by the certification organization to the manufacturer.

Representative *hollow metal* door and frame product *labels* are shown on Page 1-10 under "Listing, Labeling and Certification Organizations".

Table 1 provides the typical relationship between the opening type and location, wall *fire-resistance rating* and *fire door assembly fire-protection rating* found in the 2012 IBC.

In addition to the data tabulated there are other important requirements which apply to all *fire doors*. Among these are the following:

1. Each component of a *fire door assembly* must meet its *listing* requirements, NFPA 80 [26] and, where required, be *labeled*. The *label* covers the design, construction and compliance of that specific component only.
2. Each *fire door* must be *self-closing* or close *automatically* in the event of a fire. It must also be *self-latching* and remain closed at the time of fire in order to provide a reliable *fire barrier* [20, 66].
3. *Automatically* closing doors may be held open by a separate, *labeled*, fail-safe door holder/release device or a hold-open mechanism which is an integral part of the basic closing device, provided the hold-open mechanism is released by one or a combination of *automatic* fire detectors acceptable to the *Authority Having Jurisdiction* [20, 52].

| Type and Location of Assembly                            | Required Wall Fire-Resistance Rating (Hours)   | Required Fire Door Assembly Fire-Protection Rating (Hours) |                     |
|--|--|--|---------------------|
| <i>Fire Walls and Fire Barriers</i>                      | 4  | 3  |                     |
|  | 3  | 3  |                     |
|  | 2  | 1½   |                     |
|  | 1½   | 1½   |                     |
| <i>Shafts, Exit Enclosures and Exit Passageway Walls</i> | 2  | 1½   |                     |
| <i>Fire Barriers</i>                                     | Enclosures for Shafts, Exit Access Stairways and Ramps, Interior Exit Stairways and Ramps, Exit Passageway Walls | 1  | 1                   |
|  | Other Fire Barriers  | 1  | ¾                   |
| <i>Fire Partitions</i>                                   | Other than Corridor Walls  | 1  | ¾                   |
|  | Corridor Walls   | ½  | 1/3(A,B)            |
| <i>Smoke Barriers</i>                                    | Corridor Walls   | 1  | 1/3(A,C,D)          |
|  |  | ½  | 1/3(A,B,D)          |
| Exterior Walls   |  | 1  | 1/3(A,C,D)          |
|  |  | 3  | 1½                  |
|  |  | 2  | 1½                  |
| Smoke Partitions   |  | 1  | ¾                   |
|  |  | None   | None <sup>(D)</sup> |

- (A): Doors and their *glazing materials* may be tested as "No Hose Stream" (NHS) [15].
- (B): *Frame product* and their *glazing materials* must be ½ Hr "With Hose Stream" (WHS) tested [14].
- (C): *Frame product* and their *glazing materials* must be ¾ Hr "With Hose Stream" (WHS) tested [15].
- (D): Smoke control tested and *labeled* in accordance with UL1784 and installation per NFPA 105 required [11,15].

**WALL VS FIRE DOOR ASSEMBLY [14] AND FIRE WINDOW ASSEMBLY [21] FIRE RATINGS**

TABLE 1

4. As per NFPA 80 <sup>[53]</sup> power operated *fire doors* must be equipped with a detection device which will *automatically* cut the power to the operator. The operator must then cause the door to close and latch.
5. *Fire doors* serving a required *means of egress* from places of assembly having an *occupancy load* of 100 persons or more must be equipped with *fire exit hardware*. Such hardware is *labeled* both for *fire* and *panic protection*. The *label* is intended to differentiate between *fire exit hardware* and *panic exit hardware*. Only *fire exit hardware* is permitted to be used on *fire door assemblies* per NFPA 80 <sup>[29, 41, 71]</sup>.
6. Unless *listed* otherwise all pairs of hollow metal *fire doors* must be provided with an over-lapping steel *astragal*. Pairs of doors that require an *astragal* must have at least one attached in place so as to project approximately 3/4" (19 mm) or as otherwise indicated in the individual manufacturer's published *listings* <sup>[81]</sup>. NFPA 80 mandates that doors swinging in pairs within a *means of egress* cannot be equipped with *astragals* that inhibit the free use of either leaf.

The foregoing requirement essentially prohibits the use of overlapping *astragals* within a *means of egress* and restricts the hardware to:

- a. Two vertical rod *fire exit devices* (surface or concealed), or
- b. One door - Surface or concealed vertical rod *fire exit device* and open back *strike*, and  
Other door - Latch or mortise *fire exit hardware*

For pairs of doors where only one leaf is needed to satisfy egress requirements the *active door* may have a latch or mortise *fire exit hardware*. The *inactive leaf* may have *self-latching* or *automatic flush bolts* or two point latch. A closed back *strike* would be used on the *inactive door*. An overlapping *astragal* may or may not be used as required by the individual manufacturer's *listing*. A *closer* is required on both doors and a coordinating device would be required in rooms of human occupancy.

7. *Fire door and window assemblies* must be installed in accordance with NFPA 80 <sup>[42, 59]</sup> and their *listings* <sup>[14]</sup>. Compliant operating clearances, recommended installation methods and tolerances are provided in NAAMM [HMMA 840](#), "Installation and Storage of Hollow Metal Doors and Frames" and ANSI/NAAMM [HMMA 841](#), "Tolerances and Clearances for Commercial Hollow Metal Doors and Frames".

All parts, *anchors* and accessories used in the installation, repair or maintenance of *fire-protection rated fire door* and *frame products* must be included in the Follow-Up Service (FUS) procedures or Factory Audit Manuals (FAM) of the original product manufacturer, as *approved* and issued by the certifier.

8. Upon completion of installation the IBC and NFPA 80 <sup>[44]</sup> require confirmation of the operation of all elements of each *fire door and fire window assembly* with a written record maintained and available to the *AHJ*.
9. NFPA 80 <sup>[45, 48]</sup> also requires these assemblies be operable at all times, maintained and inspected at least annually for compliance and a written, signed inspection report be maintained for the *AHJ*. Repair of items which could interfere with the operation of an assembly must be made and such repairs must be with parts from the original manufacturer, in accordance with the manufacturer's instructions and NFPA 80 <sup>[46, 49]</sup>. If repairs cannot be made the component or *fire door assembly* must be replaced. Maintenance and annual inspections are the responsibility of the building owner.

### Classification of Fire Door and Frame Product

*Fire doors* are *classified* by hourly rating and temperature-rise rating (TRR). *Fire door frame products* are *classified* by hourly rating only. The hourly rating indicates the duration of the fire test exposure and associated hose stream. Together they are defined as the *fire-protection rating*. Generally *fire door* and *frame product* qualifying for a specific rating also qualifies for all lower ratings.

A temperature-rise rating (TRR) on a *fire door* is in addition to the *fire-protection rating*. It indicates the code required temperature rise permissible above ambient developed on the unexposed face of the door at the 30 minute point of a standard fire test. TRR *fire door labels* indicate the temperature rise does not exceed 450°F (232°C) as required by the 2012 IBC. Previous editions of the IBC include TRR's of 250°F, 450°F and 650°F at 30 minutes. The lower the temperature rating, the better the performance. Therefore, 250°F is a higher performance rating than 450°F or 650°F. If a TRR is not indicated on the *label* or it states "Temperature Rise Exceeds ..." these indicate a non-temperature-rise rated door.

TRR doors are mandated by the governing building code. The IBC <sup>[16]</sup> can require these in *interior exit stairways*, *ramps* and *exit passageways*. In some applications they can be required for *fire doors* installed in *fire walls* and *stairways* of multi-story buildings. The TRR is applicable to only the door and its *glazing materials*. Building codes <sup>[17]</sup> generally do not permit glazed frame product in openings requiring a TRR.



## Fire Tests

The governing building code also specifies the test *standards* to be used for *fire door and window assemblies*. There are two basic protocols; "neutral" or "positive" pressure. These differ predominantly based on the position of the neutral pressure plane within the furnace during the fire exposure and the resulting pressures within the furnace.

The neutral pressure plane is the horizontal line inside the test furnace where the atmospheric pressure equals that in the lab. Neutral pressure tests have historically located the neutral pressure plane at the top of the test assembly. Positive pressure tests require it to be at 40" (1016 mm) above the sill. A schematic illustrating the basic differences is provided in Figures 1 and 2 below.

For *fire-protection rated doors, frames, transom and sidelight assemblies*, the IBC requires testing to ANSI/UL 10C or ANSI/NFPA 252. UL 10C is a positive pressure protocol and the IBC <sup>[14]</sup> requires NFPA 252 to be run under positive pressure.

For *fire-protection rated window assemblies and glazing materials* the IBC <sup>[21]</sup> mandates testing to ANSI/UL 9 or ANSI/NFPA 257, each under positive pressure.

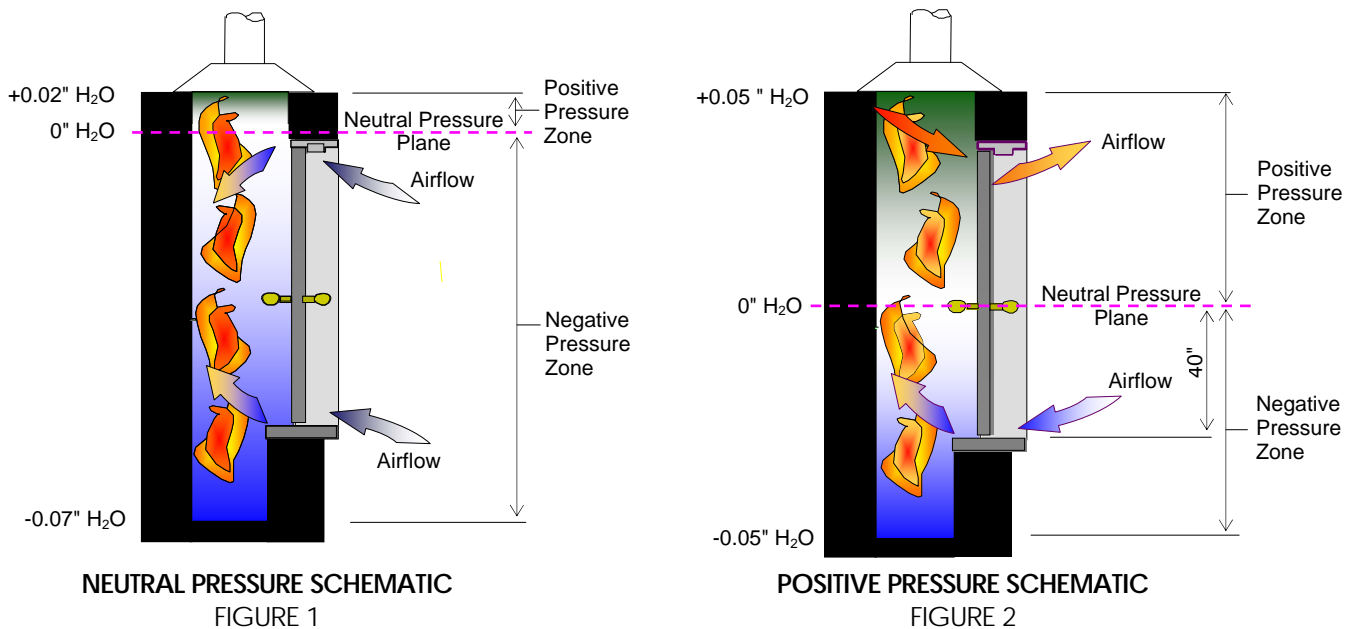

The fire test, which is generally the same in all the UL and NFPA *Standards* for doors, glazing and walls, consists of building the test assembly complete with hardware, *glazing* and wall *anchors* into a masonry, steel or wood stud wall, all contained in a movable structural steel rig. The test assembly, wall and rig are positioned on the face of a gas-fired furnace. After ignition the furnace temperature is controlled in accordance with the standard time-temperature curve shown in Figure 3 and the neutral pressure plane is located as per the specific code and test *standard* requirements.

Doors, frames, *paneled transom frames*, hardware and accessories can be tested for fire exposure periods up to 3 hours.

Except for glass block and special types of *glazing* designed for longer exposures, the length of fire exposure for *glazed transom, sidelight and window assemblies* is generally limited to ¾ hour <sup>[61]</sup>.

For testing TRR doors thermocouples are attached to the non-fire (unexposed) side of the door(s) and may also be mounted on the *glazing materials*. These record the temperatures at each location. The test *standards* describe the quantity, placement and data recording intervals. In addition a cotton pad is passed over openings in or around the door(s) while the unexposed surface temperature is below 450°F (232°C) to determine whether the passage of flame or hot gases ignite combustibles through such openings.

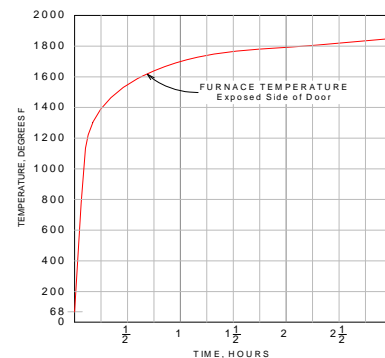

STANDARD TIME-TEMPERATURE CURVE  
FIGURE 3

Immediately after successfully completing the desired period of fire exposure the rig is moved from the furnace and the test assembly is subjected to the impact, erosion and cooling effects of a stream of water of specified nozzle pressure from a 2½" (63 mm) hose with a 1½" (28 mm) nozzle, commonly known as the "hose stream test". The water pressure and duration of application for the various *fire-protection ratings* are shown in Table 2. Fire tests of ½ hour *fire doors* and their *glazing materials* may be conducted without the hose stream as permitted by IBC.

The conditions of acceptance for performance of *fire doors* and frame product are generally the same in these test *standards* and are detailed in each.

Upon completion of the fire exposure and hose stream tests the data collected, photographs and observations of the test lab engineer are combined into a test report. The test report will include a description of the components of the test assembly and wall and will be the basis of the *listings*.

Any variation from the construction tested may substantially change the performance characteristics of the assembly. When evaluated in conjunction with the manufacturer's previous test reports, *listings* and the certification organizations policies, procedures and experience, evaluations can be performed to expand the manufacturer's *listings*. Where evaluations determine that such alternatives will not adversely impact the performance characteristics their use can be permitted.

Although fire tests are performed on complete assemblies, testing, *listing* and certification of *hollow metal products* today is focused predominantly on individual components incorporating new technologies, constructions, features, or the adaptation of existing ones to meet specialized, unique applications and/or evolving code requirements.

In order to isolate the specific component under investigation all other elements of a test assembly will generally have been tested and certified previously. Based on their decades of experience, test and certification organizations require worst-case scenario assembly test configurations. This subjects the assembly to the most severe conditions possible and provides for the evaluation of each component and their interactions. UL and WHI have been utilizing HMMA '861' welded vertically stiffened type doors for decades to evaluate hardware and door related components for use on swinging hollow metal *fire doors*.

*Glazing materials* may also be fire tested to ANSI/UL 263 or ASTM E119, the *standards* used for walls [5, 12]. As such they are assigned a *fire-resistance rating* (FRR). A FRR comprises three (3) mandatory performance criteria; fire exposure, temperature-rise and hose stream endurance. As indicated in Table 1 the typical fire exposure durations are ½, 1, 1½, 2, 3 or 4 hours. For all FRR products the average TRR cannot exceed 250°F (121°C) during the fire exposure or 325°F (163°C) at any point on the entire test assembly. The time-temperature curve and hose stream duration for walls are calculated based on 100 sq. ft. (9.29 m2) of area. The hose stream pressure is the same as those for fire doors and frame product tests.

Tested to these *Standards* they are considered "transparent, translucent, composite panels or walls". With recent changes to the IBC [12] and NFPA 80 [36] these *glazing materials* may also be used in TRR *fire doors* within the limitations of the glazing manufacturer's listings if the *glazing material* is also certified and labeled to UL 9, UL 10C, NFPA 252 or NFPA 257. Installation of such *glazing materials* in *fire-protection rated* frame product does not provide assembly compliance for openings requiring a *fire-resistance rating* to UL 263 or ASTM E119. Fire-resistance ratings for glazing materials and products are only possible when installed as part of the FRR system as explicitly described by the certification agency's certification directory for that product.

Products tested only to ISO, BSI, DIN or Euro-Norm fire test *standards* are not permitted for use in projects requiring US code compliance.

### Smoke Control Rated Assemblies

Smoke control assemblies (also referred to as "air leakage rated") reduce the migration of smoke and gases from a fire area to a protected area during the initial stages of a fire. They are mandated by the governing building code generally for assemblies in a *means of exit*, *corridors* and *smoke barriers*.

| Desired Fire-Protection Rating        | Water Pressure At Base of Nozzle<br>PSI (kPa) | Duration of Application:Sec/Ft <sup>2</sup><br>(s/m <sup>2</sup> ) of Exposed Area |
|---------------------------------------|---|--|
| 3 hours                               | 45 (310)                                      | 3.0 (32)   |
| 1½ hour and over if less than 3 hours | 30 (207)                                      | 1.5 (16)   |
| 1 hour and over if less than 1½ hours | 30 (207)                                      | 0.9 (10)   |
| Less than 1 hour                      | 30 (207)                                      | 0.6 (6)  |

HOSE STREAM TEST - PRESSURE AND DURATION  
TABLE 2

ANSI/UL 1784, "Air Leakage Tests of Door Assemblies" is the test *standard* mandated by the IBC<sup>[11, 15]</sup>. It is not part of the fire tests described above and is performed on separate samples, independent of fire tests. Therefore a smoke control rating is separate from and in addition to any *fire-protection* or TRR which may be required.

Assemblies are tested with the doors swinging into and out of a pressurized test chamber at room temperature and 400°F (205°C), at three (3) pressure differentials; 0.1", 0.2" and 0.3" of water (25, 50 and 75 Pa). The IBC<sup>[11, 15]</sup> and ANSI/NFPA 105 require a maximum air leakage rate of 3 ft<sup>3</sup>/minute/ft<sup>2</sup> (0.9 m<sup>3</sup>/minute/m<sup>2</sup>) of door area at a pressure of 0.1" of water (25 Pa) for both ambient and 400°F (205°C). A schematic of the test apparatus appears in Figure 4.

Since 3-sided *hollow metal frames* do not react in any significant way when heated to 400°F (205°C) the door and gasketing are the critical components for assembly compliance. As a result UL, WHI/ITS and FM frames are not required to bear "smoke control" compliance *labels*.

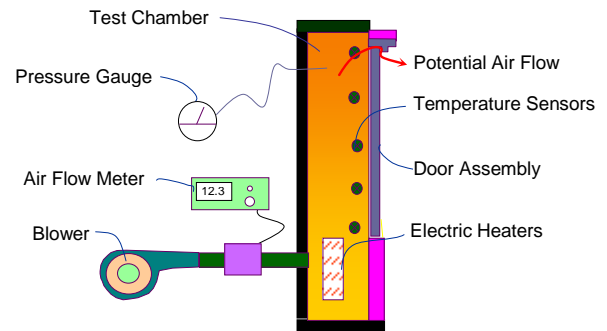

**SMOKE CONTROL TEST APPARATUS**  
FIGURE 4

All doors require some type of gasketing to meet the smoke control requirements. This gasketing is different from and in addition to the edge-sealing systems which may be required for wood doors to meet positive pressure fire test requirements.

UL, WHI/ITS and the IBC<sup>[18]</sup> have adopted a common symbol to identify fire rated product which is also smoke control compliant. The UL or WHI/ITS *label* will include . The symbol may appear on the product's fire *label* or may be on a separate *label* as illustrated in Figure 5.



**SMOKE CONTROL DOOR LABELS**  
FIGURE 5

The IBC<sup>[11, 15]</sup> requires smoke control assemblies to be installed in accordance with ANSI/NFPA 105, "Standard for the Installation of Smoke Door Assemblies and Other Opening Protectives" and the field installation instructions provided with each component product.

The IBC<sup>[11]</sup> also has provision for smoke control assemblies in openings which are not *fire-protection rated*. In such applications the door and gasketing are provided with smoke control *labels* only as shown in Figure 5 but without the  symbol.

As well the IBC allows for doors which "provide an effective barrier to limit the transfer of smoke" or be "close fitting"<sup>[1,2,3,9,10,11]</sup>. These are not required to be *fire-protection* or smoke control rated.

UL and WHI/ITS have adopted the following system of product categories to define the various components required for positive pressure and/or smoke control compliant swinging door and frame assemblies;

- Category A; *Fire doors* which do not require the addition of other components such as edge seals to comply with positive pressure requirements.
- Category B; *Fire doors* which require the addition of a Category G edge seal to comply with positive pressure requirements. The edge seals are added to the door edge or frame.
- Category C; *Fire door frames* which require a Category B door to comply with positive pressure requirements. (Three-sided *hollow metal frames* are generally not required to be positive pressure tested and are therefore not included in Category C.)
- Category D; Generally "special purpose" door and frame assemblies which are tested and *labeled* only as an assembly.
- Category E; Builders hardware which contains combustible components or is intended for installation above the neutral pressure plane (40" (1016 mm) off the floor).
- Category F; Light kits not manufactured by the door manufacturer for installation in Category A or B *fire doors*.
- Category G; Edge sealing systems applied to doors or frame product which may or may not provide compliance for smoke control but must be installed on Category B doors for positive pressure compliance.
- Category H; *Fire-protection rated* gasketing materials which are installed on Category A and B doors to comply with the additional requirements of NFPA 105 and UL1784 for smoke control compliance.

Category J; Gasketing materials which can be installed on *fire doors* for weather stripping or sound control purposes but which do not contribute to the door complying with positive pressure requirements and may or may not contribute to meeting smoke control requirements.

*Fire-protection* and smoke control rated *hollow metal doors* are generally Category A. They must be installed with *labeled hollow metal fire door frames* and may be used with Category E hardware, Category H gasketing and may be prepared for or provided with Category F light kits.

When only a smoke control rating is required *hollow metal doors* in *hollow metal frames* with Category H gaskets may be used.

*Fire-protection rated hollow metal* sound control, commercial or detention security, bullet-resistant, radiation shielding or other application specific assembly designs may be provided under Category D.

### Safety Rated Glazing Materials

The IBC <sup>[19,21]</sup> and NFPA 80 <sup>[84]</sup> also require *glazing materials* in certain locations to comply with the Consumer Product Safety Commission *standard 16 CFR 1201*, "Safety Standard for Architectural Glazing Materials" for human impact resistance (HIR) in addition to the applicable fire test *standard*.

Fire test protocols do not include provision for HIR testing. Therefore, when mandated, in addition to its fire *label*, *glazing materials* must be permanently *marked* to indicate compliance with the code specified HIR *standard*.

Most HIR certifications are provided through the Safety Glazing Certification Council (SGCC), although other 3<sup>rd</sup> party certifiers are used by *glazing* manufacturers.

### Listing, Labeling and Certification Organizations

Qualified *fire doors*, frame product and related items are identified as such only by the presence of a *label* authorized by a certification organization acceptable to the *AHJ* such as Underwriters Laboratories (UL), Warnock Hersey/Intertek Testing Services (WHI/ITS) or Factory Mutual (FM).

The IBC <sup>[18]</sup> requires *fire door assemblies*, *fire window assemblies* and smoke control assemblies to be *labeled* by an *approved agency* and the *label* must comply with the requirements in NFPA 80 <sup>[57,63,83]</sup>.

*Labels* appropriate for various conditions and requirements are provided as evidence that the product complies with the code mandated test *standards*.

Certification organizations have developed independent policies regarding the information presented on their *labels* based on code mandated requirements. All fire *labels* indicate; the certification organization name and "*mark*" (logo); the manufacturer (by name, logo or control number); wording such as "Listed", "Approved", "Certified" or "Classified"; a description of the product such as "Fire Door", "Fire Door Frame" or "Fire Window Frame"; and a serial or control number.

All *fire door labels* must indicate the code required <sup>[18]</sup> *fire-protection rating*. *Fire door frame labels* may include the code required <sup>[18]</sup> *fire-protection rating*. Per NFPA 80 <sup>[86]</sup>, UL and WHI/ITS, frames bearing a *label* without an hourly rating and provided with masonry wall *anchors* are a maximum 3 hour *fire-protection rated*. Frames bearing a *label* without an hourly rating and provided with steel stud or wood stud *anchors* are a maximum 1½ hour *fire-protection rated*.

*Fire door* and frame product *labels* are permitted to include the maximum *fire-protection rating* the product, as provided, is eligible for, but must be at least equal to or greater than required by the governing code. As an example, hollow metal *fire doors* may be provided and *labeled* as 3 hour, installed in a frame with masonry wall *anchors* in an opening which only requires a 1½ *fire-protection rating*.

To comply with code mandated requirements all *fire doors* used in positive pressure jurisdictions must be *labeled* for and bear a statement indicating compliance with the specific test *standard* in force. UL requires the inclusion of "UL 10C" on the *fire door label* and WHI the statement "Positive Pressure to UL 10C/NFPA 252" to indicate compliance. In addition there must be statements as to the temperature rise performance and references to installation instructions. The above statements may be included on the *fire door label* or a separate "supplemental" *label*. The instructions, provided separately, must detail all aspects of installation necessary to comply with the positive pressure requirements for the specific door.

As indicated earlier, where smoke control requirements are mandated in the governing code, the S symbol must also be included <sup>[18]</sup>. Again this may be incorporated on the *fire door label* or appear on a supplemental one.

The rating of the installed assembly is equal to the lowest rating of any component. (ie; An opening composed of a frame with a 1½ hour *label*, a door with a ¾ hour *label* and hardware with 3 hour *labels* would be deemed a ¾ hour assembly, based on the ¾ hour door.)

If any required component of the assembly is omitted, does not comply with its *listed* installation requirements, is not maintained or any installed component requiring a *label* does not bear a *label*, then the entire assembly is considered non-labeled.

In addition, the installation of non-labeled components on *fire-protection rated* and *labeled fire door or window assemblies* is not permitted, voids the *labels* and rating of the assembly.

Certification organizations may also require additional information on their specific *labels*. Examples include differentiating between doors reinforced for *fire exit hardware* and those for *single-point* locks/latches. Certification organizations may require a Factory Identification *Mark* to identify the facility applying the *label*.

The IBC <sup>[18]</sup> requires *fire door assembly labels* to comply with NFPA 80 <sup>[27]</sup> which provides for adhesive-backed metal or mylar *labels*, metal *labels* which can be riveted or welded to the product, or *labels* embossed (stamped) directly in the product. See Page 1-10 for facsimiles of UL and WHI/ITS IBC and NFPA 80 compliant *fire door and frame product labels* applied by member manufacturers. Printed metal or mylar applied *labels* are not intended to be painted. Embossed applied tin frame *labels* should be painted to avoid corrosion and possible obscuration. Labels embossed directly in frame product may be painted, however they must be legible afterward.

As per NFPA 80 <sup>[28]</sup> *labels* must be located so as to be readily visible and convenient for identification after installation. Except as noted, below *labels* are applied at approximately eye level on a frame hinge jamb and the hinge edge of each door leaf. If continuous hinges are specified, metal or mylar *labels* are generally applied to the inside of the top end channel or the top of a welded steel top cap (if provided) at the hinge end for *hollow metal doors* and at the hinge end of the head/horizontal *transom mullion* door rabbet for frame product.

UL, WHI/ITS and FM evaluate products on the basis of their performance under the fire endurance and hose stream tests already described. They require that their representatives witness the fire test when conducted at facilities other than their own. When inter-laboratory agreements exist this requirement may be waived.

Fire testing is only the first stage of the *listing*, certification and *labeling* process. UL, WHI/ITS and FM Follow-Up Service (FUS) programs verify *labeled* product conformance by conducting frequent unscheduled inspections for quality control and product fabrication at the *labeling* facility.

Fire *labels* are applied only at the manufacturer's factory or the facilities of UL or WHI/ITS *approved* distributors for that manufacturer <sup>[18]</sup>.

Authorization for the application of fire *labels* is granted under UL or WHI/ITS Certification / Listing Agreements and Licenses and their respective Follow-Up Service (FUS) Procedures or Factory Audit Manuals (FAM). These detail the responsibilities and the requirements for *labeling* relating to the construction, size and rating of eligible products.

The IBC <sup>[18]</sup> allows components of the same *fire door or window assembly* to be *listed* and *labeled* by different certification organizations.

Codes, by-laws or other regulations may contain provisions, applications or requirements which contradict those of UL and/or WHI/ITS. In such cases the minimum requirements of the certification organization must be met before their *labels* can be applied.

When a door or frame does not comply with the certification organization's minimum requirements, the manufacturer cannot *label* the product, however upon request may provide a Letter of Certification (LOC) attesting to the construction of the product.

## Representative UL and WHI/ITS Labels Used on Hollow Metal Fire Doors

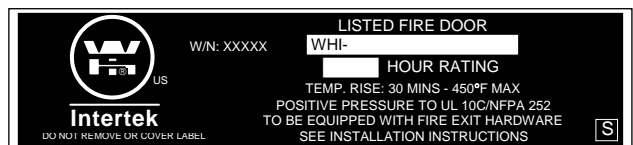
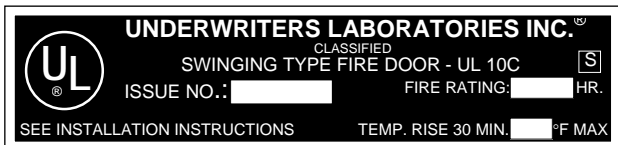
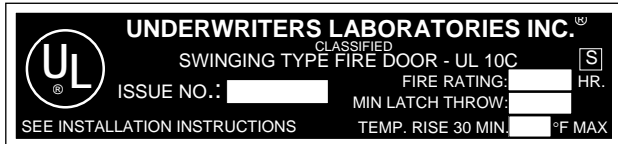
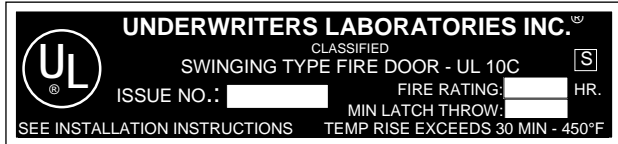

## Representative UL and WHI/ITS Labels Used on Fire Door Frame Product

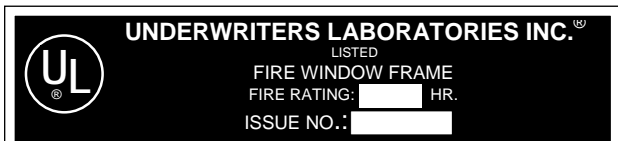
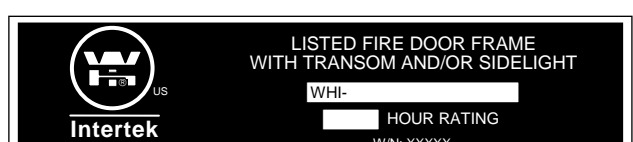
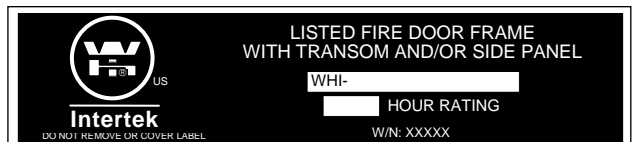

Applied to components of field assembled UL KD, Slip-On or field spliced *frame product*, removable HM *mullions* and panels.

Note: Manufacturer must also be identified on each product either by:

- A supplementary label bearing the manufacturer's name, or
- A combination label bearing the required information together with the manufacturer's name, or
- A label bearing the certifier's procedure, file or reference number for the manufacturer.
- A reference number to the manufacturer's name or file

## Representative UL and WHI/ITS Embossed Frame Labels

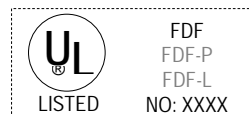

Embossed (stamped) into *frame product* hinge jamb or hinge *mullion*. Fire-protection rating is 3 hours with masonry *anchors*, 1½ with wood or steel stud *anchors*, unless indicated otherwise. "NO: XXXX" is a specific identifier assigned by the certification agency to individual manufacturers.

Abbreviations: FDF = Fire Door Frame  
Optional: FDF-P = Fire Door Frame - Paneled  
FDF-L = Fire Door Frame - Glazed

## Field Labeling and Field Modifications

The application of *labels* or the modification of *labeled* door or frame product in the field is not permitted except under UL or WHI/ITS Field Inspection Programs <sup>[47]</sup>. Field modification not authorized by the manufacturer or performed by other than the manufacturer's designated certifier are not permitted, will void the fire-rating of the entire opening, the manufacturer's warranty and any liability. Contact the product manufacturer for additional information on these programs.

The following are not considered field modifications by NFPA 80 <sup>[25]</sup>, UL or WHI/ITS and are therefore permitted to be performed on site.

1. Drilling of; function holes for *labeled* locks and *fire exit hardware*; ¾" (19 mm) diameter holes (maximum) for *labeled door viewers* <sup>[35]</sup> and; drilling and tapping required for mounting *labeled* hardware.
2. Installation of *listed* and *labeled* 3<sup>rd</sup> party *astragals*, hardware, gaskets and other related items.
3. Installation of *astragals* provided by the door manufacturer.
4. Installation of *labeled glazing materials*, 3<sup>rd</sup> party *labeled glazing kits* or *fire door louvers* in prepared door openings.
5. Installation of *labeled glazing materials* in frame product.
6. Installation of *protective plates* on doors in accordance with ANSI/NFPA 80 <sup>[79]</sup> and the protective plate manufacturer's *listings* and installation instructions.
7. Installation of the frame manufacturer's *approved* loose wall *anchors*, hollow metal removable *mullions*, flush or rabbeted hollow metal *panels* (above doors) in frame product.
8. Assembly of *knocked-down*, slip-on or field spliced frame product <sup>[60]</sup>.
9. Installation of signage in accordance with NFPA 80 <sup>[25]</sup>.

## Design Limitations

It is essential that the Architect recognizes the design limitations of *fire door* and *window assemblies* required to be *fire-protection rated* and *labeled*. Some of these limitations have already been covered but there are others too, which cannot be disregarded.

*Hollow metal fire doors and frames* may be manufactured from hot rolled, cold rolled, galvanized, galvanized or stainless steel. Frames are available with single or double rabbet profiles.

Additional design limitations due to hardware, code or other regulatory requirements are provided on Page 3-32 and are applicable to all manufacturers.

*Fire door and window assemblies* are not designed, intended, or by code and NFPA 80 <sup>[24,54,56]</sup> permitted to be *load bearing* elements. Structural support from over-head wall loads must be provided independently as part of the wall system.

Only *labeled fire-protection rated (FPR)* or where permitted, *fire-resistance rated (FRR) glazing materials* may be used <sup>[13,19,34,63,83]</sup>. The IBC mandates *FPR glazing materials* must comply with the requirements and limitations of NFPA 80 and *FRR glazing materials* may only be used within the limits of their individual *listings* <sup>[19,31]</sup>. *Glazing materials* must meet all code specified impact safety standards <sup>[19,32]</sup>. Refer to **Tables 3 and 4** on Pages 1-14 and 1-15 for the general limitations on *labeled glazing materials* permitted in *fire-protection rated hollow metal door and frame product*.

*Glazing materials* are not generally supplied or installed by the hollow metal manufacturer. However coordination between the Architect, general contractor, *glazing* supplier, *glazing* installer and the door and frame manufacturer are imperative to ensure the hollow metal is prepared appropriately and the installed *glazing materials* will not void the fire-rating of the opening <sup>[33]</sup>.

The 2012 IBC <sup>[14]</sup> does not permit *glazing materials* in doors greater than 1½ hour rating. For glazed frame product greater than ¾ hour rating, the frame and *glazing material* must be *fire-resistance rated* and rated equal to that of the partition <sup>[14,62]</sup>.

The selection of hardware is of particular importance. Only hardware which is *labeled* to the appropriate fire and hose stream standards is permitted. The type of hardware specified may limit the assembly size or *fire-protection rating*.

*Self-closing* devices are required on all *fire doors* and the *inactive leaf* of all pairs must have *automatic* or *self-latching* top and bottom bolts except when used on rooms not normally occupied by humans. Refer to the IBC <sup>[20]</sup>, NFPA 80 <sup>[87]</sup> and Page 2-3 for exceptions.

All single doors and the *active leaves* of pairs must be provided with an active latch which cannot be held in the retracted position <sup>[20]</sup>. When *single-point latching hardware* is used the maximum permissible door size may be governed by the length of the latch throw. These limitations may differ from manufacturer to manufacturer due to differences in construction details.

*Panic exit hardware* is not permitted on *fire doors*. To be acceptable such devices must also be *labeled* as *fire exit hardware*.

These regulations are some of the most important with respect to hardware. They indicate the complexity of the rules affecting design features. For a more comprehensive and detailed explanation of hardware requirements see [Section 2](#), "Hardware for Swinging Hollow Metal Fire Doors" and [Section 3](#), "Hollow Metal Fire Doors and Frame Product" in this document.

*Listings* for *labeled* doors, frame product, hardware, *glazing materials* and other certified components may be found in the "[Fire Resistance Directory](#)" published by Underwriters Laboratories, the Warnock Hersey/Intertek Testing Services "[Directory of Listed Products](#)" and the Factory Mutual Research "[Approval Guide](#)".

Each product category in the certification listings also includes a preamble which details the parameters to which the products are tested, evaluated and certified. Limitations with respect to variations from the preamble for size, rating, construction or application will be detailed in the individual product's *listing*.

Requests for information, clarification or assistance are welcomed by members of the Hollow Metal Manufacturers Association, a Division of NAAMM.

### Local Regulations; The Architect's Responsibilities

It should be emphasized that the foregoing has of necessity dealt with generally accepted national requirements but not all of these *standards* necessarily apply in all locations. A 'jurisdictional hierarchy' exists for codes and *standards*. The IBC can be modified by individual States, which can then be amended by County or 'regional' codes. Municipal codes, regulations and bylaws can then supersede all the foregoing. Interpretation and enforcement of building code, by-law or other regulatory requirements are the responsibility of the local *Authority Having Jurisdiction (AHJ)*. The *AHJ* generally bases their requirements on the local building code, NFPA *standards* and normally requires products to bear fire *labels*. Such products must conform in every respect to the *labeling* or approval requirements of the certification organization.

It is not the intent of this document to provide definitive, detailed information relating to building compartmentalization or to define the required fire ratings for the openings on a specific project. Once the Architect has fully defined these requirements, HMMA members can provide their expertise in meeting these needs.

The Architect therefore must be knowledgeable of the local code as well as requirements imposed by the owner or the insurance company. The Architect must analyze, interpret and determine all relevant requirements.

The Architect must establish and denote in the specifications the fire test methods governing the *fire doors and frame products*. For each opening the Architect's project door and frame schedule must indicate which openings are to be rated, the *fire-protection ratings* required, all temperature-rise, smoke control, human impact ratings and the materials that are acceptable.

The Architect must resolve, in advance, such conflicts as may exist between codes and *labeling* requirements and clearly specify what is to be provided so as to avoid any possible misunderstandings.

The hardware specifier is responsible for ensuring that the appropriate types of hardware are used. The door manufacturer, who is generally nationally oriented, often located at some distance from the job site, cannot be expected to be familiar with all local requirements unless the Architect provides this information. It is the Architect's responsibility, therefore, not only to ensure that the building is properly designed and protected from a fire, life safety and regulatory stand-point, but to fully inform the door manufacturer as to what is required under local regulations to accomplish this.



## Guidelines for Proper Usage

The following guidelines should be observed:

1. Ensure that the project specifications and door and frame schedules include all essential information regarding *fire door* and *window assemblies* such as the mandated test *Standard(s)*, the required *fire-protection rating*, temperature-rise rating, smoke control rating, type of door design, desired jamb and trim profiles and type of frame anchorage.
2. Specify that *fire doors, frames and hardware* be supplied by manufacturers subscribing to a nationally recognized Certification, *Listing* and Follow-Up Service program.
3. Specify that all *fire doors and frames* have the proper fire *labels* attached. Use only *labeled* frames with *labeled* doors. Use only *labeled* hardware with *labeled* doors.
4. Ensure that sizes of doors and frames do not exceed those allowed.
5. If the doors and/or frame products are to be glazed ensure that the types, dimensions, areas and fire-ratings are within prescribed limits and that only *labeled glazing materials* are used.
6. Ensure that the proper types of hardware (hinges, latches, *closers*, etc.) are specified and that no chains, hook-backs or other devices are installed to prevent the free operation and latching of the door at any time.
7. If unique designs of doors or frames are contemplated, acceptability may need to be obtained by testing or evaluation. Such processes are time consuming and costly.
8. If special frame profiles are used, ensure that they comply with the *fire-rating* requirements and are compatible with the specified hardware.
9. Ensure that combustible floor coverings do not extend through openings protected by 3 hour *fire door assemblies* <sup>[43]</sup>.
10. Check the requirements of the local code, by-laws and the insurance company involved for any other regulatory requirements.
11. Ensure that door and frame *labels* are not altered, removed or relocated in the field and that printed metal or mylar *labels* are not painted.

## Ranges of Types and Sizes Available

*Hollow metal fire doors and frames* of various ratings and designs are supplied by member manufacturers. Some offer a wide variety; others a more limited choice. Because the requirements for 3 hour assemblies are the most severe the choices are limited. The range available for the other ratings is much broader and since each manufacturer has its own methods of construction, each offers a somewhat different selection. The development and improvement of *fire door* design is an ongoing process and the selection of products changes from time to time.

[Section 3](#), Hollow Metal Fire Doors and Frame Product, provides detailed information on the *fire-protection rating* and availability of NAAMM-HMMA products. Once the Architect has determined the requirements from a *fire-protection rating* stand-point, to select the appropriate project specific constructions, refer to NAAMM [HMMA 805](#), "Recommended Selection and Usage Guide for Hollow Metal Doors and Frames". This document provides detailed guidance based upon performance expectations including occupancy types, projected usage, impact probability, abuse and maintenance and is comprehensive with regard to the application of products covered by our [HMMA 860-Series](#) Guide Specifications.

The industry's leading manufacturers of *fire-protection rated* doors and frames are members of the Hollow Metal Manufacturers Association. A summary of representative types of doors and frames offered by member companies are shown on Pages [1-14](#) and [1-15](#) and more detailed information in [Section 3](#). Each company provides its own product literature describing in detail the items it produces. Before specifying *fire door assemblies* the literature of the intended supplier should always be consulted. The NAAMM website ([www.naamm.org](http://www.naamm.org)) contains a roster with links to [member companies](#).

**Representative Types of Hollow Metal Fire Doors<sup>(C)</sup>** (See Table 3 for Glazing Limitations)

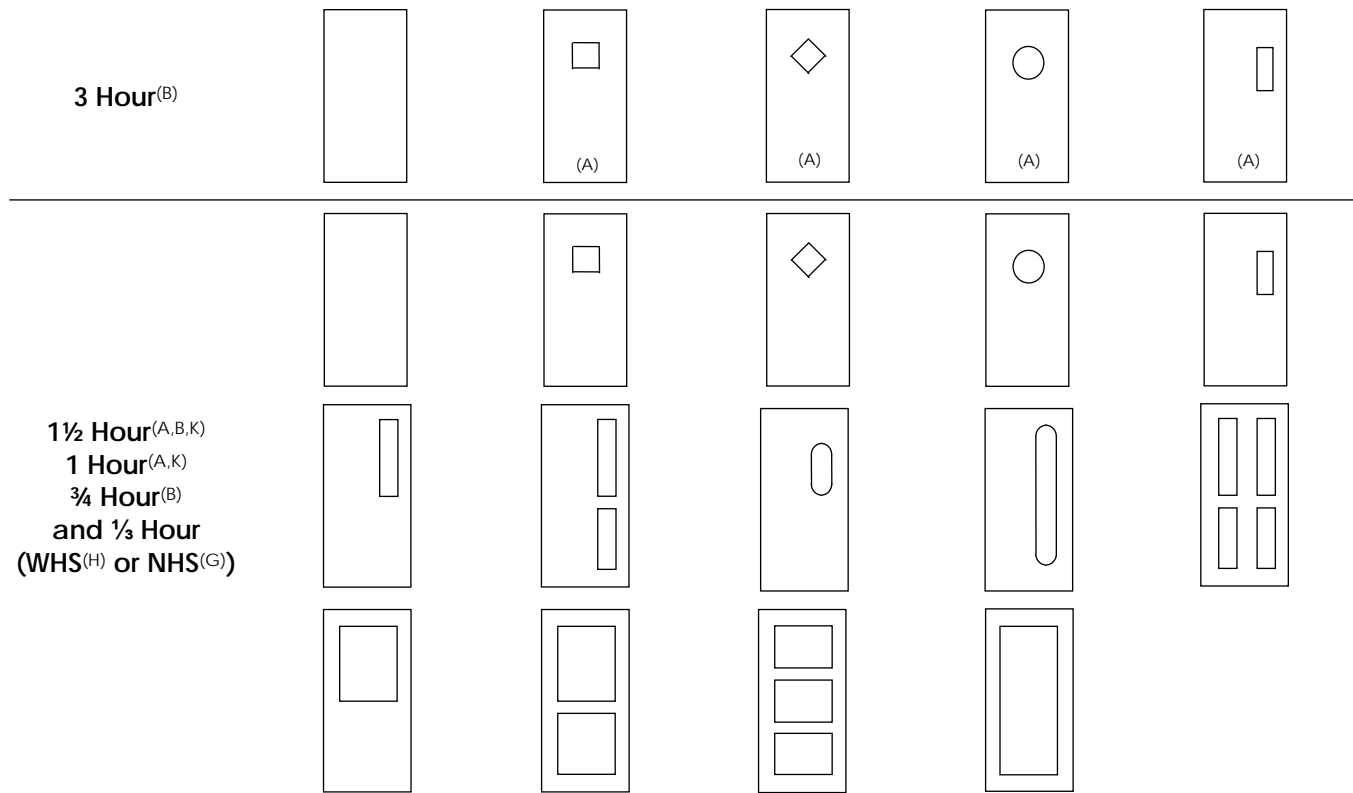

Table 3 summarizes, by *fire-protection or fire-resistance rating*, the maximum areas, widths and heights<sup>(M)</sup> of commercially available *glazing materials labeled by either UL or WH/ITS* for use in positive pressure compliant *hollow metal fire doors*. Users are advised to consult individual *glazing manufacturer's listings* for specific limitations, restrictions, requirements and Human Impact Resistance (HIR) compliance.

| Labeled Material  |               | 3 Hour <sup>(A,E,N)</sup>                   | 1 1/2 Hour <sup>(A,E,N)</sup>               | 1 Hour <sup>(A,E,N)</sup>                   | 3/4 & 1/2 Hour <sup>(D)</sup><br>(WHS <sup>(H)</sup> ) | 1/2 Hour (NHS <sup>(D,G)</sup> )            | 3/4 & 1 1/2 Hour TRR Doors <sup>(A,E,N)</sup> |
|---|---------------|---|---|---|--|---|---|
| Laminated Glazing <sup>(L)</sup>  | Area          | 100 in <sup>2</sup> (0.065 m <sup>2</sup> ) | 4990 in <sup>2</sup> (3.23 m <sup>2</sup> ) | 4990 in <sup>2</sup> (3.23 m <sup>2</sup> ) | 4990 in <sup>2</sup> (3.23 m <sup>2</sup> )            | 4990 in <sup>2</sup> (3.23 m <sup>2</sup> ) | 4990 in <sup>2</sup> (3.23 m <sup>2</sup> )   |
|   | Width         | 12" (305 mm)                                | 126" (3200 mm)                              | 126" (3200 mm)                              | 126" (3200 mm)   | 126" (3200 mm)                              | 126" (3200 mm)                                |
|   | Height        | 33" (838 mm)                                | 126" (3200 mm)                              | 126" (3200 mm)                              | 126" (3200 mm)   | 126" (3200 mm)                              | 126" (3200 mm)                                |
| Ceramic Glazing <sup>(K)</sup>  | Area          | 100 in <sup>2</sup> (0.065 m <sup>2</sup> ) | 2034 in <sup>2</sup> (1.32 m <sup>2</sup> ) | 3204 in <sup>2</sup> (2.07 m <sup>2</sup> ) | 3204 in <sup>2</sup> (2.07 m <sup>2</sup> )            | 3204 in <sup>2</sup> (2.07 m <sup>2</sup> ) | 100 in <sup>2</sup> (0.065 m <sup>2</sup> )   |
|   | Width         | 12" (305 mm)                                | 36" (914 mm)                                | 36" (914 mm)                                | 36" (914 mm)   | 36" (914 mm)                                | 12" (305 mm)                                  |
|   | Height        | 33" (838 mm)                                | 56 1/2" (1435 mm)                           | 89" (2260 mm)                               | 89" (2260 mm)  | 89" (2260 mm)                               | 33" (838 mm)                                  |
| 1/4" (6 mm) Wired Glass With Specialized Glazing Compounds <sup>(J,K)</sup> | Area          |   | 2208 in <sup>2</sup> (1.43 m <sup>2</sup> ) | 2208 in <sup>2</sup> (1.43 m <sup>2</sup> ) | 2856 in <sup>2</sup> (1.84 m <sup>2</sup> )            | 3289 in <sup>2</sup> (2.12 m <sup>2</sup> ) | 100 in <sup>2</sup> (0.065 m <sup>2</sup> )   |
|   | Qty of Lights | Not Permitted                               | Up to 4 lights                              | Up to 4 lights                              | No Limit   | No Limit                                    | 1 light                                       |
|   | Width         |   | 12" (305 mm)                                | 12" (305 mm)                                | 34" (864 mm)   | 36" (914 mm)                                | 12" (305 mm)                                  |
| 1/4" (6 mm) Wired Glass <sup>(J,K)</sup>                                    | Area          |   | 100 in <sup>2</sup> (0.065 m <sup>2</sup> ) | 100 in <sup>2</sup> (0.065 m <sup>2</sup> ) | 1296 in <sup>2</sup> (0.84 m <sup>2</sup> )            | 3289 in <sup>2</sup> (2.12 m <sup>2</sup> ) | 100 in <sup>2</sup> (0.065 m <sup>2</sup> )   |
|   | Width         | Not Permitted                               | 12" (305 mm)                                | 12" (305 mm)                                | 54" (1372 mm)  | 36" (914 mm)                                | 12" (305 mm)                                  |
|   | Height        |   | 33" (838 mm)                                | 33" (838 mm)                                | 54" (1372 mm)  | 92" (2337 mm)                               | 33" (838 mm)                                  |
| 3/8" (9.5 mm) Cement Board  | Area          |   |   |   | 3072 in <sup>2</sup> (1.99 m <sup>2</sup> )            | 3072 in <sup>2</sup> (1.99 m <sup>2</sup> ) |   |
|   | Width         | Not Permitted                               |   |   | 36" (914 mm)   | 36" (914 mm)                                |   |
|   | Height        |   |   |   | 96" (2438 mm)  | 96" (2438 mm)                               |   |

- (A): Where permitted by the AHJ
- (B): Including TRR
- (C): *Glazing material* may limit the types of doors permitted
- (D): Maximum per light
- (E): Maximum area per leaf
- (G): NHS = No Hose Stream
- (H): WHS = With Hose Stream
- (J): With or without safety film (with safety film = HIR)
- (K): *Fire-Protection Rated (FPR)*. See Note N
- (L): *Fire-Protection Rated and Fire-Resistance Rated*
- (M): Must meet all 3 criteria
- (N): The 2012 IBC<sup>[14]</sup> requires lights greater than 100 in<sup>2</sup> area in doors exceeding 3/4 hour fire rating to use *fire-resistance rated (FRR) glazing*

Note: Not all types or maximum sizes are available from all manufacturers

**LABELLED GLAZING MATERIALS FOR HOLLOW METAL FIRE DOORS**

TABLE 3

## Representative Types of Fire Door Frame Product

### 3 Hour

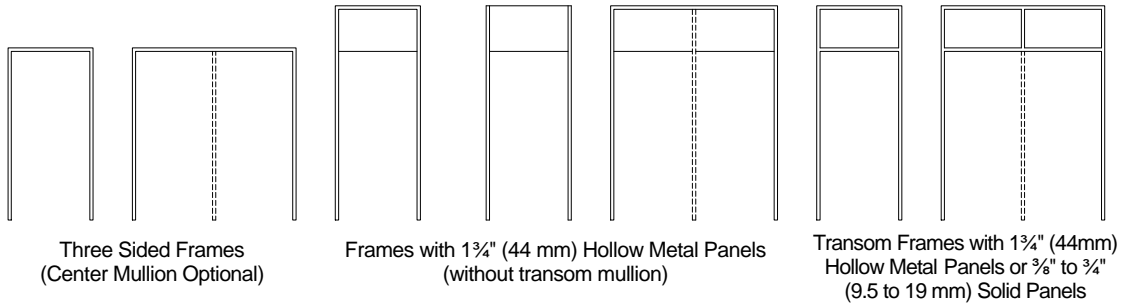

### 1 1/2 Hour and 1 Hour Any 3 Hour Frame Assembly Plus:

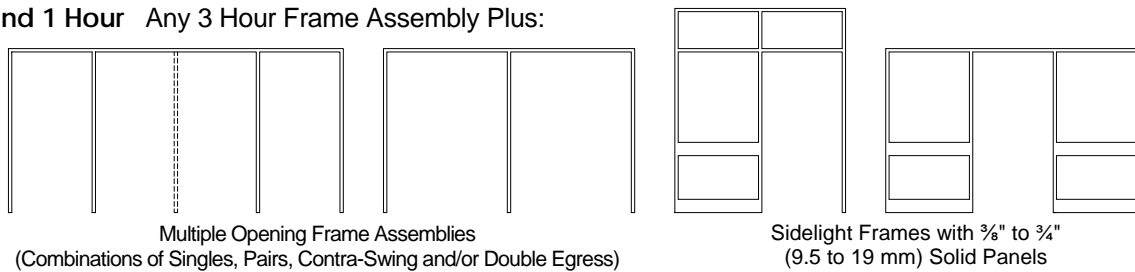

### 3/4 Hour and 1/3 Hour (WHS<sup>(A)</sup>) Any 3, 1 1/2 or 1 Hour Frame Assembly Plus:

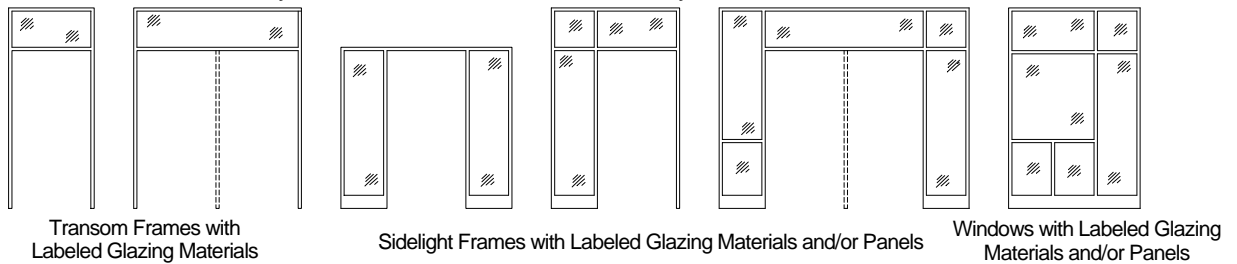

Table 4 summarizes by *fire-protection rating*, the maximum individual areas, widths and heights of commercially available materials *labeled* by either **UL** or **WHI/ITS** for use in positive pressure compliant *transom, sidelight and window assemblies*. Users are advised to consult individual *glazing* manufacturer's *listings* for specific limitations, restrictions, requirements and Human Impact Resistance (HIR) compliance.

| Labeled Material  |        | 3 Hour <sup>(E)</sup>                      | 1 1/2 Hour <sup>(E)</sup>                  | 1 Hour <sup>(E)</sup>                      | 3/4 Hour <sup>(A,B)</sup>                   | 1/3 Hour (WHS <sup>(A,B)</sup> )            |
|---|--------|--|--|--|---|---|
| Panels <sup>(D)</sup>   | Area   | 4608 in <sup>2</sup> (2.97m <sup>2</sup> ) | 4608 in <sup>2</sup> (2.97m <sup>2</sup> ) | 4608 in <sup>2</sup> (2.97m <sup>2</sup> ) | 4608 in <sup>2</sup> (2.97m <sup>2</sup> )  | 4608 in <sup>2</sup> (2.97m <sup>2</sup> )  |
|   | Width  | 96" (2438 mm)                              | 96" (2438 mm)                              | 96" (2438 mm)                              | 96" (2438 mm)                               | 96" (2438 mm)                               |
|   | Height | 48" (1219 mm)                              | 48" (1219 mm)                              | 48" (1219 mm)                              | 48" (1219 mm)                               | 48" (1219 mm)                               |
| Laminated Glazing   | Area   | Not Permitted                              | 3724 in <sup>2</sup> (2.4m <sup>2</sup> )  | 3724 in <sup>2</sup> (2.4m <sup>2</sup> )  | 5605 in <sup>2</sup> (3.62m <sup>2</sup> )  | 6272 in <sup>2</sup> (4.05m <sup>2</sup> )  |
|   | Width  | Not Permitted                              | 111" (2818 mm)                             | 111" (2818 mm)                             | 96" (2438 mm)                               | 106 1/2" (2705 mm)                          |
|   | Height | Not Permitted                              | 111" (2819 mm)                             | 111" (2819 mm)                             | 96" (2438 mm)                               | 106 1/2" (2705 mm)                          |
| Ceramic Glazing   | Area   | Not Permitted                              | 2627 in <sup>2</sup> (1.69m <sup>2</sup> ) | 3325 in <sup>2</sup> (2.15m <sup>2</sup> ) | 3325 in <sup>2</sup> (2.15m <sup>2</sup> )  | 3325 in <sup>2</sup> (2.15m <sup>2</sup> )  |
|   | Width  | Not Permitted                              | 56 1/2" (1435 mm)                          | 95" (2413 mm)                              | 95" (2413 mm)                               | 95" (2413 mm)                               |
|   | Height | Not Permitted                              | 56 1/2" (1435 mm)                          | 95" (2413 mm)                              | 95" (2413 mm)                               | 95" (2413 mm)                               |
| 1/4" (6 mm) Wired Glass <sup>(C)</sup> With Specialized Glazing Compounds | Area   | Not Permitted                              | Not Permitted                              | Not Permitted                              | 4608 in <sup>2</sup> (3.03m <sup>2</sup> )  | 4608 in <sup>2</sup> (3.03m <sup>2</sup> )  |
|   | Width  | Not Permitted                              | Not Permitted                              | Not Permitted                              | 100" (2540 mm)                              | 100" (2540 mm)                              |
|   | Height | Not Permitted                              | Not Permitted                              | Not Permitted                              | 100" (2540 mm)                              | 100" (2540 mm)                              |
| 1/4" (6 mm) Wired Glass <sup>(C)</sup>                                    | Area   | Not Permitted                              | Not Permitted                              | Not Permitted                              | 1296 in <sup>2</sup> (0.84 m <sup>2</sup> ) | 1296 in <sup>2</sup> (0.84 m <sup>2</sup> ) |
|   | Width  | Not Permitted                              | Not Permitted                              | Not Permitted                              | 54" (1372 mm)                               | 54" (1372 mm)                               |
|   | Height | Not Permitted                              | Not Permitted                              | Not Permitted                              | 54" (1372 mm)                               | 54" (1372 mm)                               |

(A): WHS = With Hose Stream; The IBC <sup>[15]</sup> permits *fire door assemblies* in 1 hr *corridor walls* and *smoke barriers* with *fire doors* and their *glazing materials* at 1/3 hr NHS but requires *frame product* and their *glazing materials* to be 3/4 hr WHS rated.

(B): For 1/2 hr partitions *fire doors* and their *glazing materials* may be 1/3 hr NHS tested, however *frame product* and their *glazing materials* must be 1/3 hr WHS rated.

(C): With or without safety film (with safety film = HIR)

(D): Provided as an integral part of the frame product and as such the frame *label* includes the *panels*

(E): The 2012 IBC <sup>[14,21]</sup> and NFPA 80 <sup>[62]</sup> do not permit *fire-protection rated* glazed frame product where the required *fire-rating* exceeds 3/4 hour

Note: Not all types or maximum sizes are available from all manufacturers

## LABELLED MATERIALS FOR TRANSOM, SIDELIGHT AND WINDOW ASSEMBLY OPENINGS

TABLE 4

INTENTIONALLY BLANK PAGE

## HARDWARE FOR SWINGING HOLLOW METAL FIRE DOORS

### CONTENTS

---

|   |     |
|---|-----|
| General Hardware Requirements .....                       | 2-2 |
| Builders Hardware for Singles<br>and Pairs of Doors ..... | 2-2 |
| Hinges .....  | 2-2 |
| Pivots .....  | 2-2 |
| Locks, Latches and Deadbolts .....                        | 2-3 |
| Fire Exit Hardware .....                                  | 2-3 |
| Closers .....   | 2-4 |
| Gasketing Materials .....                                 | 2-4 |
| Protection Plates .....                                   | 2-5 |
| Door Viewers .....  | 2-5 |
| Builders Hardware for Pairs of Doors .....                | 2-5 |
| Flush Bolts .....   | 2-5 |
| Surface Bolts .....                                       | 2-5 |
| Coordinators .....  | 2-5 |
| Hardware Code Summary .....                               | 2-6 |

## General Hardware Requirements

Hardware requirements for *fire door assemblies* are outlined in ANSI/NFPA 80<sup>[37]</sup>, "Standard for Fire Doors and Other Opening Protectives" <sup>[14]</sup>. This *Standard* refers to hardware for *fire doors* as "Builders Hardware" and "Fire Door Hardware". Builders hardware is applied only to swinging doors <sup>[38]</sup> and includes; hinges; single, two and three point locks or latches; *fire exit devices*; top and bottom bolts; and *door closers* <sup>[39]</sup>. *Fire exit hardware* consists of exit devices which have been *labeled* both for *fire* and *panic protection* <sup>[41]</sup>. *Fire door hardware* can be applied to either swinging or sliding doors and includes; surface-mounted strap hinges; surface-applied latches; and closing devices.

*Labeled* hardware for *fire door assemblies* is required for all *fire-protection rated* openings from 1/3 hour to 3 hours.

When positive pressure tested doors and frames are specified hardware *labeled* to same *standards* is also generally required.

The following is a summary of hardware which can be used on swinging *hollow metal fire doors*. The alphanumeric code shown in parentheses following each item is used in [Section 3](#) - Hollow Metal Fire Doors and Frame Product, to indicate appropriate hardware for different *fire door* types and applications. For additional guidance refer to NAAMM-HMMA 830, "Hardware Selection for Hollow Metal Doors and Frames".

*Listings* for *labeled* hardware are found in the "[Fire Resistance Directory](#)" under "[Fire Door Hardware](#)" published by Underwriters Laboratories, the Warnock Hersey/Intertek Testing Services "[Directory of Listed Products](#)" and the Factory Mutual Research "[Approval Guide](#)".

Each hardware category in the certification listings also includes a preamble which details the parameters to which the category is tested, evaluated, certified and *labeled*. Limitations with respect to variations from the preamble for size, rating, construction or application will be detailed in the individual product's *listing*. Hardware is typically rated for use on door leaves up to 4' x 8' for three hours unless specifically indicated otherwise in the individual *listings*.

Hardware is not generally supplied by the hollow metal manufacturer and is not required to be installed at the labeling facility or shipped with *fire doors* or *frame product* <sup>[40]</sup>.

### Builders Hardware for Singles and Pairs of Doors

#### Hinges (Steel)

##### Butt Type

- Full Mortise (H1)
- Half Mortise (H2)
- Half Surface (H3)
- Full Surface (H4)

##### Mortise

- Self-Closing Type (H6)
- Swing Clear Type
- Full Mortise (H7)
- Half Mortise (H8)
- Half Surface (H9)
- Full Surface (H10)

##### Continuous Type

- Edge Mount (H11)
- Half Edge Mount (H12)
- Half Surface (H13)
- Full Surface (H14)

##### Anchor Type (H5)

##### Invisible Type

- Mortise (H15)

#### Pivots (Steel)

- Offset (Top, Bottom and Intermediate) (H16)
- Pocket (H17)

The minimum sizes for hinges and pivots, maximum door sizes and fire-ratings, unless *listed* otherwise, must be as per NFPA 80 <sup>[69]</sup> and [Table 5](#) on Page 2-3.

Doors up to 5' (1524 mm) in height must be provided with two hinges and an additional hinge for each additional 2'6" (762 mm) of door height or fraction thereof.

All hinges and pivots, except *spring hinges*, must be ball bearing type. Hinges or pivots employing other than anti-friction bearing surfaces are permitted if they meet the requirements of [ANSI A156.1](#), "Standard for Butts and Hinges".

4½" (114 mm) high, 0.180" (4.57 mm) thick hinges are recommended for wide and heavy doors or doors that are subjected to heavy use or unusual stress.

Some manufacturers can prepare *fire door and frame product* for hinges of lighter weight (thickness) that are not of the ball bearing type when they are part of a *labeled* assembly, meet the requirements of [ANSI A156.1](#), "Standard for Butts and Hinges" and have been tested to a minimum of 350,000 cycles.

Steel, mortise or surface, ball-bearing type butt hinges which comply with NPFA 80 are not required to be tested, *listed* or fire *labeled*. All other hinges and pivots, including continuous, electrified, power transfer, pocket and invisible types must be tested, *listed* and fire *labeled*.

Where *labeled self-closing spring hinges* are used, a minimum of 2 per *fire door leaf* are required. For *fire door* openings exceeding 60" (1524) height a 3<sup>rd</sup> hinge is required either; another *labeled spring hinge*; a steel, mortise, ball bearing type hinge matching the height and thickness of the *spring hinges*; or a specific mortise hinge as indicated in the *spring hinge* manufacturer's listings. *Self-closing spring hinges* must be *labeled*.

Electric hinges of equivalent height and weight to those detailed in Table 5 are permitted.

Full length, *labeled* continuous hinges are permitted within the size and rating limitations of their individual listings. Reinforcing requirements and mounting must be in accordance with the hinge manufacturer's *listings*, templates and installation instructions.

Pivot sets with components that are smaller or of a lighter weight (thickness) shown in Table 5 are permitted provided they meet the requirements of ANSI A156.4, "Door Controls (Closers)" and are in accordance with the pivot manufacturer's *listings*.

Invisible hinges (H15) and pocket pivots (H17) are limited to 4' x 8' (1219 x 2438 mm) maximum leaf size.

| Maximum Fire Door Assembly Rating (Hours) | Maximum Door Size |                  | Minimum Hinge Size |                       | Hinge Type   |
|---|-------------------|------------------|--------------------|-----------------------|--|
|   | Width Feet (mm)   | Height Feet (mm) | Height Inches (mm) | Thickness Inches (mm) |  |
| 3   | 4 (1219)          | 8 (2438)         | 4½ (114)           | 0.134 (3.40)          | Steel, mortise or surface                                    |
| 3   | 4 (1219)          | 10 (3048)        | 4½ (114)           | 0.180 (4.57)          | Steel, mortise or surface                                    |
| 1½  | 3'2 (965)         | 8 (2438)         | 6 (152)            | 0.225 (5.72)          | Steel, olive knuckle or paumelle                             |
| 3   | 4 (1219)          | 10 (3048)        | 4 (102)            | 0.225 (5.72)          | Steel, offset pivots   |
| 1½  | 3 (914)           | 5 (1524)         | 4 (102)            | 0.130 (3.30)          | Steel, mortise or surface                                    |
| 1½  | 2 (610)           | 3 (914)          | 3 (76)             | 0.092 (2.34)          | Steel, mortise or surface                                    |
| 3   | 3 (914)           | 7 (2134)         | 4 (102)            | 0.105 (2.67)          | Steel, mortise or surface (labeled self-closing spring type) |

MORTISE, SURFACE AND SELF-CLOSING SPRING HINGES OR PIVOTS FOR 1¾" (44 mm) THICK FIRE DOORS<sup>[69]</sup>

TABLE 5

**Lock, Latches and Deadbolts** <sup>[70]</sup>

- |   |  |
|---|--|
| Mortise Latch or Lock (Single & Three Point) (L1) | Cylindrical (Bored) Deadlock (L5) (See Exceptions) |
| Cylindrical (Bored) Latch or Lock (L2)            | Power Operated Strike (L6)                         |
| Pre-Assembled Latch or Lock (L3)                  | Power Operated Latch (L7)                          |
| Mortise Deadlock (L4) (See Exceptions below)      |  |

**Fire Exit Hardware** <sup>[71]</sup>

- |                     |                               |   |
|---------------------|-------------------------------|---|
| Single Doors:       | Two Single Doors with Mullion | Pairs of Doors:                           |
| Rim Type (FEH1)     | Between Doors:                | Rim Type (FEH1) with Mullion Behind Doors |
| Mortise Type (FEH2) | Rim Type (FEH1)               | Mortise Type (FEH2)                       |
|                     | Mortise Type (FEH2)           | Surface Vertical Rod Type (FEH3)          |
|                     |                               | Concealed Vertical Rod Type (FEH4)        |

All single doors and the *active leaf* of all pairs of *fire doors* must be provided with an active latch bolt (one that cannot be held in a retracted position). Exceptions <sup>[72]</sup> may include;

- Doors other than those used in a *means of egress* or with *fire exit hardware* may be provided with dead bolts in addition to the active latch bolt where permitted by the *Authority Having Jurisdiction*.
- Locks with dead bolts which are interconnected with latch bolts and retract when the latch bolt is retracted are permitted on *fire doors* within a *means of egress*.
- Latching arrangements that do not provide positive latching in the normal mode are permitted provided that in a fire emergency the door becomes positively latched by means of an *automatic* fail-safe device that is activated by an *automatic* fire detector.

Only *labeled* locks or latches meeting both life safety and *fire-protection* requirements can be used.

Unless indicated otherwise in the individual door and hardware manufacturer's *listings*, minimum latch throw for: single doors up to 8' (2438 mm) height - ½" (12.7 mm); singles over 8' (2438 mm) height and all pairs - ¾" (19 mm).

Where both leaves of a pair are required for *exit* purposes both must be provided with *labeled fire exit hardware* <sup>[73]</sup>.

Exception: Where acceptable to the *Authority Having Jurisdiction* pairs of doors not provided with an *astragal* may be permitted with *labeled fire exit hardware* and an open back *strike* installed on the *inactive leaf* and either *labeled mortise fire exit hardware* or any *labeled* latch capable of being opened by one obvious operation from the egress side installed on the *active leaf* <sup>[74]</sup>.

Where a pair of doors is needed for the movement of equipment and where the *inactive leaf* of a pair of doors is not required for *exit* purposes, *labeled* top and bottom and *self-latching* or *automatic flush bolts* or *labeled* two point latches with *coordinator* are permitted <sup>[75]</sup>.

Exception: Manually operated, *labeled* top and bottom *flush* or *surface bolts* on the *inactive leaf* of a pair of doors may be permitted when acceptable to the *Authority Having Jurisdiction* provided they do not pose a hazard to life safety <sup>[76]</sup>. This provision limits their use to rooms not normally occupied by humans (e.g. transformer vaults, storage rooms). The *inactive leaf* may not require a *closer*.

Vertical rod *fire exit hardware* (FEH3 and FEH4) may be provided without bottom rods, commonly called "Less Bottom Rod (LBR.)"

Open back *strikes* may be used on the *inactive leaf* of pairs *listed* for their use <sup>[77]</sup>. Open back *strikes* are limited to use on hollow metal doors up to 1½ hour *fire-protection rating*.

Doors and/or frame product must be prepared for the *strike(s)* indicated in the latching hardware manufacturer's *listings* and templates.

Many hardware manufacturers produce power operated devices that have been tested, *listed* and *labeled* from both an electrical and *fire-protection* standpoint and are eligible for use in *hollow metal fire door assemblies* <sup>[78]</sup>. For electrical compliance, additional certification of the hardware to NFPA 70, Article 722, National Electrical Code, Class 2 Circuit is required. Low voltage (12 or 24 VDC) hardware is not required to be listed for electrical safety. Hardware required for burglary resistance, access control or control of egress must be specifically listed and labeled as such.

#### Closers

|  |   |
|--|---|
| Surface Mounted on Pull-Side Face of Door (C1) | Concealed in Head with Exposed Arm (C5)     |
| Concealed in Door with Exposed Arm (C2)        | Concealed in Transom Mullion (C6)           |
| Surface Mounted on Push-Side Face of Door (C3) | Floor Mounted for Hinged Doors (C7)         |
| Concealed in Head with Concealed Arm (C4)      | Floor Mounted for Offset Pivoted Doors (C8) |

Except as indicated below, each *fire-protection rated* leaf and its door opening must be prepared for a *self-closing* device <sup>[11,67,87]</sup>.

Exceptions: *Dutch doors*, where a *closer* is required on the top leaf only,  
The *inactive leaf* of fire rated pairs in rooms not normally occupied by people,  
On one leaf of communicating *fire doors*, or  
When *labeled* floor *closers* (pivots) or *spring hinges* are used.

Combination *closer/holders* which have an *approved* release mechanism are permitted.

Fire doors may not use door closers that have hold open arms unless the hold open arm incorporates a fusible link or listed door holder mechanism wired to a smoke detector or the building alarm system.

#### Gasketing Materials <sup>[82]</sup>

Gasketing materials (3<sup>rd</sup> party weather stripping, sound or light seals, *astragals*, door bottoms, etc.) on *fire doors* or *frames* may be furnished only in accordance with the gasketing material manufacturer's published *listings*.

Exception: Where acceptable to the *Authority Having Jurisdiction*, gasketing materials of noncombustible or limited combustible material (see ANSI/NFPA 220 "Standard on Types of Building Construction") may be applied to the frame provided closing and latching of the door are not inhibited.

*Labeled* gasketing materials are intended for installation with *fire doors* and/or *fire door frame* product, as specified in the individual gasket manufacturer's *listings*. These materials are installed in the field in accordance with the instructions provided with the gasketing.



These materials have been investigated to determine that their installation does not adversely affect the *fire-protection* performance or the free operation of the *fire door assembly*. The performance of a gasketing material is observed during the fire test to ensure that flaming does not occur on the unexposed surface of the assembly.

It is important to note however that fire tests do not include evaluation of the door assembly relative to preventing the migration of smoke or other products of combustion through or around the assembly. See Pages 1-6 and 1-7 for additional information on smoke control requirements and gasketing.

Gasketing materials fire tested, *listed* and *labeled* as the 'stop' in *hollow metal fire door* openings are permitted on cased-open jambs, heads and *mullions* occurring at the perimeter of the *fire-protection rated* doors in frame product.

Gasketing materials used at the meeting edges of *fire-protection rated* pairs are not intended to replace a required over-lapping steel *astragal* or to alter the clearance requirements between pairs of doors specified in NFPA 80 <sup>[42]</sup>. Additionally, gasketing materials may not be used to reduce the clearances between the top or vertical edges of *fire-protection rated* doors and the frame, or the bottom of *fire-protection rated* doors and the top of a non-combustible floor or threshold specified in NFPA 80 <sup>[42,59]</sup>.

### Protection Plates

*Labeled* non-metallic claddings or *protective plates* are permitted on *fire-protection rated hollow metal doors* within the limitations of the cladding/*protective plate* manufacturer's individual listings. Generally the top of the plate may be a maximum of 16" (406 mm) above the bottom of the door unless otherwise tested, *listed* and *labeled*. Such plates may be on both door faces. No other plates can be installed <sup>[79]</sup>.

### Door Viewers

*Labeled* door *viewers* are permitted in *hollow metal fire doors* up to 1½ hour rating. A *fire door* may be prepared for a maximum of 2 *viewers*. The preparation, a ¾" (19 mm) diameter maximum hole through the door, may be performed at the factory or in the field.

### Builders Hardware for Pairs of Doors

#### Flush Bolts

- Manual Type (FB1)
- Self-Latching Type, Edge Mounted Operator (FB2)
- Self-Latching Type, Surface Mounted Operator (FB3)
- Automatic Type (FB4)

Where indicated in the individual *flush bolt* manufacturer's listings, the top of the *inactive leaf* of *fire-protection rated* paired doors may be prepared for a *labeled flush bolt* and the bottom lock edge of the leaf may be prepared for a *labeled* mortised fusible link auxiliary fire latch. The auxiliary fire latch must be located 4" to 6" (102 to 152 mm) from the bottom of the door. The adjacent edge of the *active leaf* must be prepared in accordance with the auxiliary fire latch manufacturer's listing, templates and installation instructions. Maximum *fire door* leaf sizes and fire-ratings are limited by the *hollow metal fire door* and the *flush bolt* manufacturer's listings. Edge guards or any other item which may interfere with the auxiliary fire latch and its operation may not be installed on either leaf.

#### Surface Bolts

- Manual Type (SB1)

#### Coordinators

- Surface Mounted Type (CO1)
- Mortised Type (CO2)

A *coordinator* is required for pairs when an *astragal* or projecting latch bolt could prevent the *inactive* door from closing and latching before the *active door* <sup>[68]</sup>.

A *coordinator* is not required when each leaf of a pair closes and latches independently <sup>[68]</sup>.

## Hardware Code Summary

### Hinges (Steel)

- H1 - Full Mortise Butt Hinge
- H2 - Half Mortise Butt Hinge
- H3 - Half Surface Butt Hinge
- H4 - Full Surface Butt Hinge
- H5 - Anchor Hinge
- H6 - Mortise Self-Closing Spring Hinge
- H7 - Full Mortise Swing Clear Hinge
- H8 - Half Mortise Swing Clear Hinge
- H9 - Half Surface Swing Clear Hinge
- H10 - Full Surface Swing Clear Hinge
- H11 - Edge Mounted Continuous Hinge
- H12 - Half Edge Mounted Continuous Hinge
- H13 - Half Surface Continuous Hinge
- H14 - Full Surface Continuous Hinge
- H15 - Mortise, Invisible Hinge
- H16 - Offset Pivot
- H17 - Pocket Pivot

### Locks, Latches and Deadbolts

- L1 - Mortise Latch or Lock
- L2 - Cylindrical (Bored) Latch or Lock
- L3 - Pre-Assembled Latch or Lock
- L4 - Mortise Deadlock
- L5 - Cylindrical (Bored) Deadlock
- L6 - Power Operated Strike
- L7 - Power Operated Latch

### Fire Exit Hardware

- FEH1 - Rim Type
- FEH2 - Mortise Type
- FEH3 - Surface Vertical Rod Type
- FEH4 - Concealed Vertical Rod Type

### Closers (Overhead)

- C1 - Surface Mounted on Pull-Side Face of Door
- C2 - Concealed in Door with Exposed Arm
- C3 - Surface Mounted on Push-Side Face of Door
- C4 - Concealed in Head with Concealed Arm
- C5 - Concealed in Head with Exposed Arm
- C6 - Concealed in Transom Mullion

### Closers (Floor)

- C7 - For Hinged Doors
- C8 - For Offset Pivoted Doors

### Flush Bolts

- FB1 - Manual Type
- FB2 - Self-Latching Type, Edge Mounted Operator
- FB3 - Self-Latching Type, Surface Mounted Operator
- FB4 - Automatic Type

### Surface Bolts

- SB1 - Manual Type

### Coordinators

- CO1 - Surface Mounted Type
- CO2 - Mortised Type

## HOLLOW METAL FIRE DOORS AND FRAME PRODUCT

### CONTENTS

|  |      |
|--|------|
| Summary - Hollow Metal Fire Doors .....                                      | 3-2  |
| Summary - Fire Door Frame Product .....                                      | 3-5  |
| Basic Hollow Metal Fire Doors .....  | 3-7  |
| Pairs of Fire Doors in Means of Egress .....                                 | 3-8  |
| Temperature-Rise Rated Fire Doors .....                                      | 3-9  |
| Double Egress Fire Doors and Frames .....                                    | 3-10 |
| Stainless Steel Fire Doors .....   | 3-11 |
| Dutch Hollow Metal Fire Doors .....  | 3-12 |
| Louvered Hollow Metal Fire Doors .....                                       | 3-13 |
| Three-Sided Frames .....   | 3-14 |
| Multiple Opening Frames .....  | 3-15 |
| Frames with 1¼" (44 mm) Transom<br>Panels without Transom Mullions .....     | 3-16 |
| Transom Frames with 1¼" (44 mm)<br>Transom Panels and Transom Mullions ..... | 3-17 |
| Transom Frames with Transom Panels<br>and Transom Mullions .....             | 3-18 |
| Transom Frames - Glazed .....  | 3-19 |
| Multiple Opening Transom Frames -<br>Glazed or Paneled .....                 | 3-20 |
| Sidelight and Window Frames -<br>Glazed or Paneled .....                     | 3-21 |
| Application Specific Fire Door<br>and Frame Assemblies;                      |      |
| Sound Control .....  | 3-23 |
| Commercial Security .....  | 3-24 |
| Detention Security .....   | 3-25 |
| Bullet-Resistant .....   | 3-26 |
| Radiation Shielding .....  | 3-27 |
| Profiles for Fire Door Frame Product .....                                   | 3-28 |
| Anchors for Fire Door Frame Product .....                                    | 3-29 |
| Other Design Limitations for<br>Fire Door and Frame Product .....            | 3-32 |

**SUMMARY - HOLLOW METAL FIRE DOORS<sup>(K)</sup>**

| Door Description and Construction Specific Information Page Number          |                                       | Basic Fire Door <sup>(F)</sup><br>3-7 |         |          |         |          |          |          |           |          |         | Pairs in a Means of Egress <sup>(F)</sup><br>3-8 |           |         |          |          |          |          |          |
|---|---------------------------------------|---------------------------------------|---------|----------|---------|----------|----------|----------|-----------|----------|---------|--|-----------|---------|----------|----------|----------|----------|----------|
|   |                                       | 3                                     |         |          |         |          | 1½       |          |           |          |         | 3  |           | 1½      |          |          |          |          |          |
| Maximum Fire-Protection Rating (Hours) <sup>(A)</sup>                       |                                       | Single                                |         |          | Pair    |          |          |          | S         |          |         | Pair   |           | Pair    |          |          |          |          |          |
|   |                                       | 4' x 8'                               | 4' x 9' | 4' x 10' | 8' x 8' | 8' x 10' | 8' x 10' | 8' x 10' | 10' x 12' | 5' x 12' | 8' x 8' | 8' x 10'   | 10' x 12' | 8' x 8' | 8' x 10' | 8' x 8'  | 8' x 10' |          |          |
| Face Sheets   | 0.032"<br>(0.8 mm, 20 ga)             | •                                     |         |          | •       |          |          |          |           |          | •       |  |           | •       |          | •        |          |          |          |
|   | 0.042"<br>(1.0 mm, 18 ga)             |                                       | •       | •        |         |          | •        |          |           |          |         |  |           |         | •        |          | •        |          |          |
|   | 0.053"<br>(1.3 mm, 16 ga)             |                                       | •       | •        |         |          | •        |          | •         |          | •       | •  |           |         | •        |          | •        |          |          |
|   | 0.067"<br>(1.7 mm, 14 ga)             |                                       | •       | •        |         |          | •        |          | •         |          | •       | •  |           |         | •        |          | •        |          |          |
|   | 0.093"<br>(2.3 mm, 12 ga)             |                                       | •       |          |         |          |          |          |           |          |         |  |           |         |          |          |          |          |          |
| Single Door, Active Leaf of Pair or Both Leaves of 2 Singles <sup>(D)</sup> | Lock or Latch <sup>(B)</sup>          | •                                     | •       | •        | •       |          |          |          |           | •<br>(H) | •       |  |           | •       | •<br>(H) | •<br>(J) | •<br>(J) | •<br>(J) | •<br>(J) |
|   | Mortise Fire Exit Hardware            | •                                     | •       | •        | •       | •        | •        |          |           |          | •       | •  | •         | •       |          | •        | •        | •        | •        |
|   | Rim Fire Exit Hardware <sup>(C)</sup> | •                                     | •       | •        |         | •        |          |          |           |          |         | •  |           |         |          |          |          |          |          |
|   | Vertical Rod Fire Exit Hardware       |                                       |         |          |         | •        |          |          | •         |          |         |  |           |         | •        | •        |          | •        |          |
| Inactive Leaf of Pair   | Rim Fire Exit Hardware <sup>(C)</sup> |                                       |         |          | •       |          |          | •        |           |          | •       |  |           |         |          |          |          |          |          |
|   | Vertical Rod Fire Exit Hardware       |                                       |         |          | •       | •        |          | •        | •         |          | •       |  |           | •       | •        | •        | •        | •        | •        |
|   | Standard Strike <sup>(E)</sup>        |                                       |         |          | •       | •        |          | •        | •         |          | •       | •  | •         | •       | •        | •        | •        | •        | •        |
|   | Open Back Strike <sup>(G)</sup>       |                                       |         |          |         |          |          |          |           |          | •       | •  | •         | •       |          |          | •        | •        |          |
|   | Flush Bolts                           |                                       |         |          | •       |          |          | •        |           |          | •       |  | •         | •       | •        |          |          |          |          |
| With Over Lapping Astragal  |                                       |                                       |         |          |         |          |          |          |           |          |         |  |           |         |          |          |          |          |          |
| Without Over Lapping Astragal   |                                       |                                       |         |          | •       | •        | •        | •        | •         | •        | •       | •  | •         | •       | •        | •        | •        | •        |          |

Notes

Continued next page

- (A): Plus all lower ratings
- (B): ½" (12.7 mm) minimum latch throw for singles to 8'0" height, ¾" (19 mm) for singles over 8'0" height and all pairs, unless *listed* otherwise
- (C): For pairs a *mullion* behind the doors is required
- (D): With a hollow metal *mullion* between each door
- (E): With standard *strike* requires *coordinator* and carry bar
- (F): Includes hot rolled, cold rolled, galvanized, galvalume and Type 430 stainless steel
- (G): In lieu of 'standard' *strike and coordinator*
- (H): Mortise lock or latch only
- (J): Where acceptable to the AHJ
- (K): Not all constructions, sizes, ratings or features are provided by each manufacturer. Consult individual member companies for more specific guidance.

**SUMMARY - HOLLOW METAL FIRE DOORS<sup>(N)</sup>**

| Door Description and Construction Specific Information Page Number            |                                       | Temperature-Rise Rated Door <sup>(F)</sup><br>3-9 |   |    |  |   |   | Double Egress <sup>(F)</sup><br>3-10              |                  | Stainless Steel Door (Type 304 or 316) <sup>(L)</sup><br>3-11 |         |    |         |
|---|---------------------------------------|---|---|----|--|---|---|---|------------------|---|---------|----|---------|
| Maximum Fire-Protection Rating (Hours) <sup>(A)</sup>                         |                                       | 3   |   | 1½ |  |   |   | 3   | 1½               | 3   |         | 1½ |         |
| Maximum Door Opening  |                                       | S   | Pair  |    | Single   | Pair  |   | Pair  | P                | S   | Pair    |    | P       |
|   |                                       | 4' x 8' <sup>(J)</sup><br>4' x 10' <sup>(K)</sup> | 8' x 8' <sup>(J)</sup><br>8' x 10' <sup>(K)</sup> |    | 4' x 10' <sup>(J)</sup><br>5' x 12' <sup>(K)</sup> | 8' x 10' <sup>(J)</sup><br>10' x 12' <sup>(K)</sup> |   | 8' x 8' <sup>(M)</sup><br>8' x 10' <sup>(M)</sup> | 8' x 10'         | 4' x 8'   | 8' x 8' |    | 8' x 8' |
| Face Sheets   | 0.032" (0.8 mm, 20 ga)                |   |   |    |  |   |   | •   | •                |   |         |    |         |
|   | 0.042" (1.0 mm, 18 ga)                | •   | •   | •  | •  | •   | • | •   | •                | •   | •       | •  | •       |
|   | 0.053" (1.3 mm, 16 ga)                | •   | •   | •  | •  | •   | • | •   | •                | •   | •       | •  | •       |
|   | 0.067" (1.7 mm, 14 ga)                | •   | •   | •  | •  | •   | • | •   | •                |   |         |    |         |
|   | 0.093" (2.3 mm, 12 ga)                |   |   |    |  |   |   |   |                  |   |         |    |         |
| Single Door, Active Leaf of a Pair or Both Leaves of 2 Singles <sup>(D)</sup> | Lock or Latch <sup>(B)</sup>          | •   | •   |    | •  | • <sup>(H)</sup>                                    |   | •   | • <sup>(H)</sup> |   | •       | •  | •       |
|   | Mortise Fire Exit Hardware            | •   | •   | •  | •  |   | • | •   |                  | •   | •       | •  | •       |
|   | Rim Fire Exit Hardware <sup>(C)</sup> | •   |   | •  | •  |   |   |   |                  | •   |         | •  |         |
|   | Vertical Rod Fire Exit Hardware       |   |   |    | •  |   | • | •   | •                |   |         | •  | •       |
| Inactive Leaf of Pair   | Rim Fire Exit Hardware <sup>(C)</sup> |   |   | •  |  |   |   |   |                  |   | •       |    |         |
|   | Vertical Rod Fire Exit Hardware       |   | •   | •  |  | •   | • | •   | •                |   | •       | •  | •       |
|   | Standard Strike <sup>(E)</sup>        |   | •   | •  |  | •   | • | •   |                  | •   | •       |    | •       |
|   | Open Back Strike <sup>(G)</sup>       |   |   |    |  |   | • |   |                  |   |         |    | •       |
|   | Flush Bolts                           |   | •   |    |  |   | • | •   |                  | •   |         |    |         |
| With Over Lapping Astragal  |                                       |   |   |    |  |   |   | •   | •                | •   | •       | •  | •       |
| Without Over Lapping Astragal   |                                       |   | •   | •  | •  | •   | • | •   | •                |   |         |    | •       |

Notes

- (A): Plus all lower ratings
- (B): ½" (12.7 mm) minimum latch throw for singles to 8'0" height, ¾" (19 mm) for singles over 8'0" height and all pairs, unless *listed* otherwise
- (C): For pairs a *mullion* behind the doors is required
- (D): With a hollow metal *mullion* between each door
- (E): With standard *strike* requires *coordinator* and carry bar
- (F): Includes hot rolled, cold rolled, galvanized, galvalume and Type 430 stainless steel
- (G): In lieu of 'standard' *strike*
- (H): Mortise lock or latch only
- (J): 250°F, 450°F or 650°F at 30 minute TRR
- (K): 450°F or 650°F at 30 minute TRR
- (L): See Page 3-11 for Type 430 stainless steel doors
- (M): Includes Type 304 and 316 stainless steel
- (N): Not all constructions, sizes, ratings or features are provided by each manufacturer. Consult individual member companies for more specific guidance

Continued next page

**SUMMARY - HOLLOW METAL FIRE DOORS<sup>(L)</sup>**

| Door Description and Construction Specific Information Page Number            |                                       | Dutch Dr <sup>(F,G)</sup><br>3-12 | Louvered Door <sup>(G)</sup><br>3-13 |          |          |          | Sound Control Door <sup>(G)</sup><br>3-23 |         |         | Commercial Security Door <sup>(G)</sup><br>3-24 |         |         | Detention Security Door <sup>(G)</sup><br>3-25 |         | Bullet-Resistant Door <sup>(G)</sup><br>3-26 |          | Radiation Shielding Door <sup>(G)</sup><br>3-27 |         |   |      |
|---|---------------------------------------|-----------------------------------|--------------------------------------|----------|----------|----------|---|---------|---------|---|---------|---------|--|---------|--|----------|---|---------|---|------|
| Maximum Fire-Protection Rating (Hours) <sup>(A)</sup>                         |                                       | 3                                 | 1½                                   |          |          |          | 3   |         |         | 3   |         |         | 3  |         | 3  |          | 3   |         |   |      |
| Maximum Door Opening  |                                       | S                                 | Single                               |          | Pair     |          |   |         | S       | Pair  |         | S       | Pair   |         | S  | P        | S   | P       | S | Pair |
|   |                                       | 4' x 8'                           | 4' x 8'                              | 4' x 10' | 8' x 8'  | 8' x 10' | 4' x 8'                                   | 8' x 8' | 4' x 8' | 8' x 8'   | 4' x 8' | 8' x 8' | 4' x 8' <sup>(H)</sup>                         | 8' x 8' | 4' x 10'                                     | 8' x 10' | 4' x 8'   | 8' x 8' |   |      |
| Face Sheets   | 0.032" (0.8 mm, 20 ga)                |                                   | •                                    |          | •        |          |   |         |         |   |         |         |  |         |  |          |   |         |   |      |
|   | 0.042" (1.0 mm, 18 ga)                | •                                 |                                      | •        | •        | •        | •   | •       |         |   |         |         |  |         |  |          |   | •       | • |      |
|   | 0.053" (1.3 mm, 16 ga)                | •                                 |                                      | •        | •        | •        | •   | •       |         |   |         |         |  | •       | •  | •        | •   | •       | • |      |
|   | 0.067" (1.7 mm, 14 ga)                | •                                 |                                      | •        | •        | •        | •   | •       | •       | •   | •       | •       | •  | •       | •  | •        | •   | •       | • |      |
|   | 0.093" (2.3 mm, 12 ga)                |                                   |                                      |          |          |          |   | •       | •       | •   | •       | •       | •  | •       | •  | •        | •   | •       | • |      |
| Single Door, Active Leaf of a Pair or Both Leaves of 2 Singles <sup>(D)</sup> | Lock or Latch <sup>(B)</sup>          | •                                 | •                                    | •        | •        |          |   | •       | •       | •   |         |         | •  | •       | •  | •        | •   | •       | • |      |
|   | Mortise Fire Exit Hardware            |                                   | •<br>(K)                             |          |          | •<br>(K) |   |         |         |   |         |         |  |         | •  |          | •   | •       |   |      |
|   | Rim Fire Exit Hardware <sup>(C)</sup> |                                   | •<br>(K)                             |          | •<br>(K) |          |   | •       | •       | •   | •       |         |  |         | •  |          | •   | •       |   |      |
|   | Vertical Rod Fire Exit Hardware       |                                   |                                      |          |          |          | •<br>(K)                                  |         |         | •   | •       |         | •  |         |  |          |   |         | • |      |
| Inactive Leaf of Pair   | Rim Fire Exit Hardware <sup>(C)</sup> |                                   |                                      |          | •<br>(K) |          |   |         | •       |   | •       |         |  |         |  |          |   |         |   |      |
|   | Vertical Rod Fire Exit Hardware       |                                   |                                      |          |          | •<br>(K) | •<br>(K)                                  |         |         | •   |         | •       |  |         |  |          |   |         | • |      |
|   | Standard Strike <sup>(E)</sup>        |                                   |                                      |          | •        | •        | •   | •       | •       |   | •       |         | •  |         | •  |          | •   | •       |   |      |
|   | Open Back Strike <sup>(J)</sup>       |                                   |                                      |          | •        | •        | •   | •       | •       |   |         |         |  |         |  |          |   |         | • |      |
|   | Flush Bolts                           |                                   |                                      |          | •        |          | •   | •       | •       |   | •       |         | •  |         | •  |          | •   | •       |   |      |
| With Over Lapping Astragal  |                                       | •                                 |                                      |          |          |          |   | •       | •       | •   |         | •       | •  | •       |  | •        | •   | •       | • |      |
| Without Over Lapping Astragal   |                                       |                                   |                                      |          | •        | •        | •   | •       | •       |   |         |         |  |         |  |          |   |         |   |      |

Notes

- (A): Plus all lower ratings
- (B): ½" (12.7 mm) minimum latch throw for singles to 8'0" height, ¾" (19 mm) for singles over 8'0" height and all pairs, unless *listed* otherwise
- (C): For pairs a *mullion* behind the doors is required
- (D): With a hollow metal *mullion* between each door
- (E): With standard *strike* requires *coordinator* and carry bar
- (F): Each leaf of *dutch door* must be provided with an active latch bolt. See Page 3-12 for additional information and options.
- (G): Includes hot rolled, cold rolled, galvanized, galvaneal and Type 430 stainless steel
- (H): Swinging or sliding
- (J): In lieu of 'standard' *strike*
- (K): Where acceptable to the AHJ
- (L): Not all constructions, sizes, ratings or features are provided by each manufacturer. Consult individual member companies for more specific guidance

**SUMMARY - FIRE DOOR FRAME PRODUCT(L)**

| Frame Description and Construction Specific Information Page Number |                                     | Three-Sided Frames<br>3-14 |                       |                    |                       | Double Egress Frames<br>3-10 | Multiple Opening Frames<br>3-15 | Frames with 1¼" Panel without Transom Mullion<br>3-16 |  |
|---|-------------------------------------|----------------------------|-----------------------|--------------------|-----------------------|------------------------------|---------------------------------|---|--|
| Maximum Fire-Protection Rating (Hours) <sup>(A)</sup>               |                                     | 3                          | 1½                    | 1½ <sup>(C)</sup>  |                       | 3                            | 1½                              | 3   | 1½   |
| Max. Door Opening   | Singles<br>Pairs                    | 4' x 10'<br>8' x 10'       | 5' x 12'<br>10' x 12' | 4' x 8'<br>8' x 8' | 4' x 9'<br>8' x 8'10" | -<br>8' x 10'                | 4' x 8'<br>8' x 8'              | 4' x 9'<br>8' x 9'                                    | 4' x 9'6"<br>8' x 9'6"   |
| Thickness   | 0.042"<br>(1.0 mm, 18 ga)           |                            |                       | •                  |                       |                              |                                 |   |  |
|   | 0.053"<br>(1.3 mm, 16 ga)           | •                          |                       | •                  | •                     | •                            | •                               | •   | •  |
|   | 0.067"<br>(1.7 mm, 14 ga)           | •                          | •                     |                    |                       | •                            | •                               | •   | •  |
|   | 0.093"<br>(2.3 mm, 12 ga)           | •                          | •                     |                    |                       | •                            | •                               | •   | •  |
| Material  | Mild <sup>(B)</sup> & 430 Stainless | •                          | •                     | •                  | •                     | •                            | •                               | •   | •  |
|   | 304/316 Stainless                   | •                          |                       |                    |                       | •                            |                                 |   |  |
| Anchors   | Masonry                             | •                          | •                     |                    |                       | •                            | •                               | •   | •  |
|   | Concrete                            | •                          | •                     |                    |                       | •                            | •                               | •   | •  |
|   | Wood/Steel Stud <sup>(H)</sup>      | • <sup>(J)</sup>           | •                     | •                  | •                     | • <sup>(J)</sup>             | •                               |   | •  |
| Maximum Over-All Unit Size  |                                     |                            |                       |                    |                       |                              | 12'10"<br>(Width)               | 11'2"<br>Ht <sup>(F)</sup>                            | 12' Ht <sup>(F)</sup> :Singles<br>11'2" Ht <sup>(F)</sup> :Pairs |

| Frame Description and Construction Specific Information Page Number |                                     | Transom Frames with 1¼" Panel & Transom Mullion<br>3-17 |   | Transom Frames with Panel & Transom Mullion<br>3-18  |   | Transom Frames Glazed<br>3-19 |   |
|---|-------------------------------------|---|---|--|---|-------------------------------|---|
| Maximum Fire-Protection Rating (Hours) <sup>(A)</sup>               |                                     | 3   | 1½  | 3  | 1½  | 1½ <sup>(D,E)</sup>           |   |
| Max. Door Opening   | Singles<br>Pairs                    | 4' x 10'<br>8' x 10'                                    | 5' x 11'6" <sup>(K)</sup><br>10' x 11'6" <sup>(K)</sup> | 4' x 9'6" <sup>(K)</sup><br>8' x 9'6" <sup>(K)</sup> | 5' x 11'6" <sup>(K)</sup><br>10' x 11'6" <sup>(K)</sup> | 4' x 10'<br>8' x 10'          | 5' x 11'6" <sup>(K)</sup><br>10' x 11'6" <sup>(K)</sup> |
| Thickness   | 0.042"<br>(1.0 mm, 18 ga)           |   |   |  |   |                               |   |
|   | 0.053"<br>(1.3 mm, 16 ga)           | •   |   | •  |   | •                             |   |
|   | 0.067"<br>(1.7 mm, 14 ga)           | •   | •   | •  | •   | •                             | •   |
|   | 0.093"<br>(2.3 mm, 12 ga)           | •   | •   | •  | •   | •                             | •   |
| Material  | Mild <sup>(B)</sup> & 430 Stainless | •   | •   | •  | •   | •                             | •   |
|   | 304/316 Stainless                   | •   |   | •  |   | •                             |   |
| Anchors   | Masonry                             | •   | •   | •  | •   |                               | •   |
|   | Concrete                            | •   | •   | •  | •   |                               | •   |
|   | Wood/Steel Stud <sup>(H)</sup>      | • <sup>(J)</sup>  | •   | • <sup>(J)</sup>                                     | •   |                               | •   |
| Maximum Over-All Unit Height <sup>(G)</sup>                         |                                     | 11'2"   | 12'   | 10'  | 12'   | 12'                           |   |

Notes for Page 3-5

- (A): Plus all lower ratings
- (B): Includes hot rolled, cold rolled, galvanized and galvaneal steel
- (C): Slip-On construction frames
- (D): Where acceptable to the AHJ
- (E): With *labeled* laminated or solid ceramic glazing materials
- (F): Combined door and panel height
- (G): Combined door, transom mullion and transom opening ht

Continued

- (H): A unit is considered installed "in wood/steel stud" when either a jamb, head or sill contact such a partition.
- (J): Wood stud limited to 1½ hour maximum
- (K): Based on 1¼" (31.8 mm) minimum face transom mullion and 4¾" (120.7 mm) minimum transom opening height
- (L): Not all constructions, sizes, ratings or features are provided by each manufacturer. Consult individual member companies for more specific guidance.

**SUMMARY - FIRE DOOR FRAME PRODUCT<sup>(K)</sup>**

| Frame Description and Construction Specific Information Page Number |  | Multi-Opening Transom Frames Glazed or Paneled<br>3-20 |                            |                           |                              | Sidelight Frames Glazed or Paneled<br>3-21 |            |                      | Window Frames Glazed or Paneled<br>3-21 |                     |           |   |  |
|---|--|--|----------------------------|---------------------------|------------------------------|--|------------|----------------------|---|---------------------|-----------|---|--|
| Maximum Fire-Protection Rating (Hours) <sup>(A)</sup>               |  | 1½ <sup>(D,E)</sup>                                    |                            | ¾                         |                              | 1½ <sup>(D,E)</sup>                        |            | ¾                    |   | 1½ <sup>(D,E)</sup> |           | ¾ |  |
| Max. Door Opening   | Singles<br>Pairs                               | 4' x 8'<br>8' x 8'                                     |                            | 4' x 8'<br>8' x 8'        |                              | 4' x 10'<br>8' x 10'                       |            | 4' x 10'<br>8' x 10' |   | 4' x 8'<br>8' x 8'  |           | - |  |
| Thickness   | 0.042"<br>(1.0 mm, 18 ga)                      |  |                            |                           |                              |  |            |                      |   |                     |           |   |  |
|   | 0.053"<br>(1.3 mm, 16 ga)                      | •  |                            | •                         |                              | •  |            | •                    |   | •                   |           | • |  |
|   | 0.067"<br>(1.7 mm, 14 ga)                      | •  |                            | •                         |                              | •  |            | •                    |   | •                   |           | • |  |
|   | 0.093"<br>(2.3 mm, 12 ga)                      | •  |                            | •                         |                              | •  |            | •                    |   | •                   |           | • |  |
| Material  | Mild <sup>(B)</sup> & 430 Stainless            | •  |                            | •                         |                              | •  |            | •                    |   | •                   |           | • |  |
|   | 304/316 Stainless                              |  |                            |                           |                              |  |            | •                    |   |                     |           | • |  |
| Anchors   | Masonry  | •  |                            | •                         |                              | •  |            | •                    |   | •                   |           | • |  |
|   | Concrete                                       | •  |                            | •                         |                              | •  |            | •                    |   | •                   |           | • |  |
|   | Wood <sup>(J)</sup> /Steel Stud <sup>(H)</sup> | •  |                            | •                         |                              | •  |            | •                    |   | •                   |           | • |  |
| Maximum Over-All Unit Size  |  | 12'10 x 12' <sup>(G)</sup>                             | 12'10 x 10' <sup>(G)</sup> | 13'6 x 12' <sup>(G)</sup> | 12'10 x 11'4' <sup>(G)</sup> | 13'6 x 12'                                 | 13'6 x 12' | 9'4 x 10'            | 13'6 x 12'                              | 13'6 x 12'          | 9'4 x 10' |   |  |

| Frame Description and Construction Specific Information Page Number |  | Sound Control Frs<br>3-23 |  | Commercial Security Frs<br>3-24 |  | Detention Security Frs<br>3-25    |  | Bullet Resistant Frs<br>3-26 |  | Radiation Shielding Frs<br>3-27 |  |
|---|--|---------------------------|--|---------------------------------|--|-----------------------------------|--|------------------------------|--|---------------------------------|--|
| Maximum Fire-Protection Rating (Hours) <sup>(A)</sup>               |  | 3                         |  | 3                               |  | 3                                 |  | 3                            |  | 3                               |  |
| Max. Door Opening   | Singles<br>Pairs                               | 4' x 8'<br>8' x 8'        |  | 4' x 8'<br>8' x 8'              |  | 4' x 8' <sup>(F)</sup><br>8' x 8' |  | 4' x 10'<br>8' x 10'         |  | 4' x 8'<br>8' x 8'              |  |
| Thickness   | 0.042"<br>(1.0 mm, 18 ga)                      |                           |  |                                 |  |                                   |  |                              |  |                                 |  |
|   | 0.053"<br>(1.3 mm, 16 ga)                      | •                         |  |                                 |  |                                   |  | •                            |  | •                               |  |
|   | 0.067"<br>(1.7 mm, 14 ga)                      | •                         |  | •                               |  | •                                 |  | •                            |  | •                               |  |
|   | 0.093"<br>(2.3 mm, 12 ga)                      | •                         |  | •                               |  | •                                 |  | •                            |  | •                               |  |
| Material  | Mild <sup>(B)</sup> & 430 Stainless            | •                         |  | •                               |  | •                                 |  | •                            |  | •                               |  |
|   | 304/316 Stainless                              |                           |  | •                               |  | •                                 |  | •                            |  | •                               |  |
| Anchors   | Masonry  | •                         |  | •                               |  | •                                 |  | •                            |  | •                               |  |
|   | Concrete                                       | •                         |  | •                               |  | •                                 |  | •                            |  | •                               |  |
|   | Wood <sup>(J)</sup> /Steel Stud <sup>(H)</sup> | •                         |  |                                 |  |                                   |  | •                            |  | •                               |  |

Notes for Page 3-6

- (A): Plus all lower ratings
- (B): Includes hot rolled, cold rolled, galvanized and galvaneal steel
- (C): Slip-On construction frames
- (D): Where acceptable to the AHJ
- (E): With approved panels, labeled laminated or solid ceramic glazing materials
- (F): Swinging or sliding

- (G): Over-all width x combined door, transom mullion and transom opening height
- (H): A unit is considered installed "in wood/steel stud" when either a jamb, head or sill contact such a partition.
- (J): Wood stud limited to 1½ hour maximum
- (K): Not all constructions, sizes, ratings or features are provided by each manufacturer. Consult individual member companies for more specific guidance.



## BASIC HOLLOW METAL FIRE DOORS

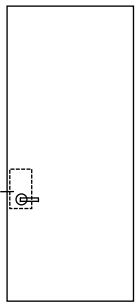

Singles

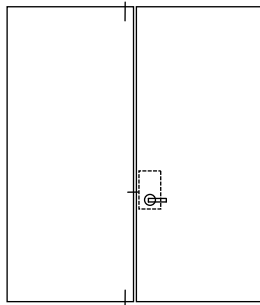

Pairs

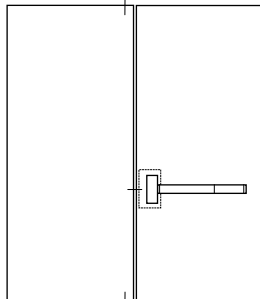
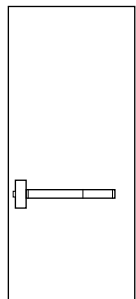

**Product:**

1¼" (44 mm) thick doors, swinging singly or in pairs, up to 3 hour *fire-protection rating*.

**Maximum Door Opening:**

3 Hour: Singles: 4'0" x 10'0" (1219 x 3048 mm)  
 Pairs: 8'0" x 10'0" (2438 x 3048 mm)  
 1½ Hour: Singles: 5'0" x 12'0" (1524 x 3658 mm)  
 Pairs: 10'0" x 12'0" (3048 x 3658 mm)

Note: Pairs may be provided without an over-lapping *astragal*.

**Maximum Leaf Size:**

3 Hour: 4'0" x 10'0" (1219 x 3048 mm)  
 1½ Hour: 5'0" x 12'0" (1524 x 3658 mm)

See Page 3-2 for additional size, gage and hardware specific information

**Glazing:**

Refer to Section 1, Table 3, Page 1-14 for requirements

**Frames:**

Any *fire-protection rated* frame product may be used.

**Specifications:**

Refer to ANSI/NAAMM HMMA 860, 861 or 867 for detailed specifications or consult individual [member companies](#)

**Hardware:**

Refer to Section 2 for detailed requirements and Page 2-6 for Hardware Code Summary

| Hardware                              | Nominal Leaf Sizes   |   |  |
|---------------------------------------|--|---|--|
|                                       | Not Exceeding<br>4'0" (1219) Width and<br>8'0" (2438) Height | Not Exceeding<br>4'0" (1219) Width and<br>Over 8'0" (2438) up to<br>10'0" (3048) Height | Over 4'0" (1219) up to 5'0"<br>(1524) Width or<br>Over 10'0" (3048) up to<br>12'0" (3658) Height |
| Hinges                                | H1 to H15  | H1 to H5 and H7 to H14  | H1 to H5 and H7 to H14   |
| Offset Pivots                         | H16 and H17  | H15   | Not Permitted  |
| Locks and Latches                     | L1, L2 and L3  | Singles: L1 and L2<br>Pairs: L1 only  | L1 only  |
| Deadbolts                             | L4 and L5  | L4 and L5   | L4 and L5  |
| Minimum<br>Latch Throw <sup>(A)</sup> | Singles: ½" (12.7 mm)<br>Pairs: ¾" (19 mm)                   | ¾" (19 mm)  | ¾" (19 mm)   |
| Fire Exit<br>Hardware                 | Singles: FEH1 and FEH2<br>Pairs: FEH1 to FEH4                | Singles: FEH1 and FEH2<br>Pairs: FEH1 to FEH4   | Not Permitted  |
| Flush Bolts                           | FB1 to FB4   | FB1 to FB4  | FB1 to FB4   |
| Overhead Closers                      | C1 to C6   | C1 to C6  | C1 to C6   |
| Floor Closers                         | C7 and C8  | C7 and C8   | Not Permitted  |

Notes:

(A): Unless indicated otherwise in individual door manufacturer's *listings*.

## PAIRS OF HOLLOW METAL FIRE DOORS IN A MEANS OF EGRESS

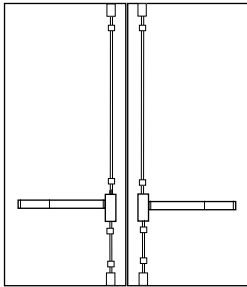

Combination 1

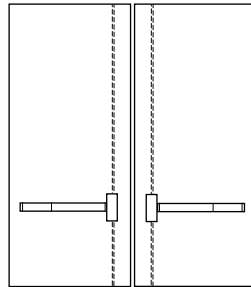

Combination 2

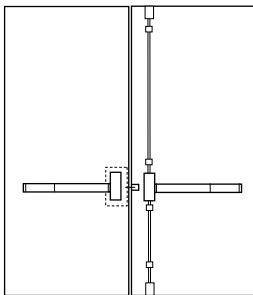

Combination 3

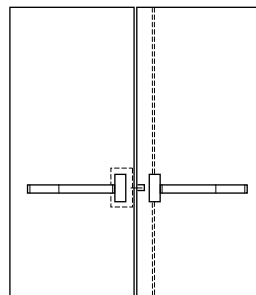

Combination 4

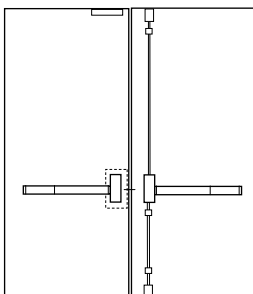
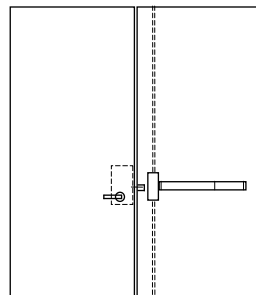
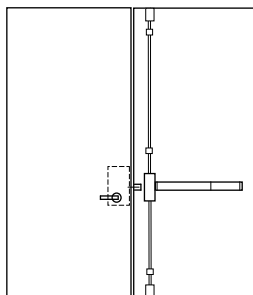

### Product:

1 $\frac{3}{4}$ " (44 mm) thick pairs of doors, swinging in the same direction, in a *means of egress*, where both leaves are required for *exit* purposes, without *astragal*, up to 3 hour *fire-protection rating*<sup>(B)</sup>.

### Maximum Door Openings:

8'0" x 10'0" (2438 x 3048 mm)

### Maximum Leaf Sizes:

4'0" x 10'0" (1219 x 3048 mm)

### Latching Hardware:

Four combinations of hardware are possible to satisfy the requirement that both leaves act as *exit* doors.

Combination 1: Surface (FEH3) or concealed (FEH4) vertical rod *fire exit hardware* on each leaf.

Combination 2: Surface (FEH3) or concealed (FEH4) vertical rod *fire exit hardware* with an open back *strike* on one leaf. Mortise (FEH2) *fire exit hardware* on other leaf.

Combination 3: Surface (FEH3) or concealed (FEH4) vertical rod *fire exit hardware* with an open back *strike* on one leaf. Any *labeled* latch (L1, L2 or L3) capable of being opened by one obvious operation from the egress side of the other leaf, where acceptable to the *Authority Having Jurisdiction*.

Combination 4: Surface (FEH3) or concealed (FEH4) vertical rod *fire exit hardware* with *strike* on one leaf. Mortise (FEH2) *fire exit hardware*, *coordinator* (CO1 or CO2), and carry bar on other leaf.

### Other Hardware:

Refer to [Section 2](#) for detailed requirements and Page 2-6 for Hardware Code Summary

Hinges:

H1 to H5 and H7 to H15

Offset Pivots:

H16 and H17

Locks and Latches:

L1, L2, L3 (for Combination 3 only)

Minimum Latch Throw<sup>(A)</sup>:

$\frac{3}{4}$ " (19 mm)

*Fire Exit Hardware*:

FEH2 to FEH4

*Flush Bolts*:

Not permitted

*Overhead Closers*:

C1 to C6

*Floor Closers*:

C7 and C8

*Coordinators*:

CO1 & CO2 (for Combination 4 only)

See Page 3-2 for additional size, gage and hardware specific information

### Glazing:

Refer to Section 1, [Table 3](#), Page 1-14 for requirements

### Frames:

Any *fire-protection rated* frame product may be used

### Specifications:

Refer to ANSI/NAAMM HMMA [860](#), [861](#), [866](#) or [867](#) for detailed specifications or consult individual [member companies](#).

### Notes:

(A): Unless indicated otherwise in individual door manufacturer's *listings*.

(B): Other constructions are available. Contact individual [member manufacturers](#) for additional information

## TEMPERATURE-RISE RATED HOLLOW METAL FIRE DOORS

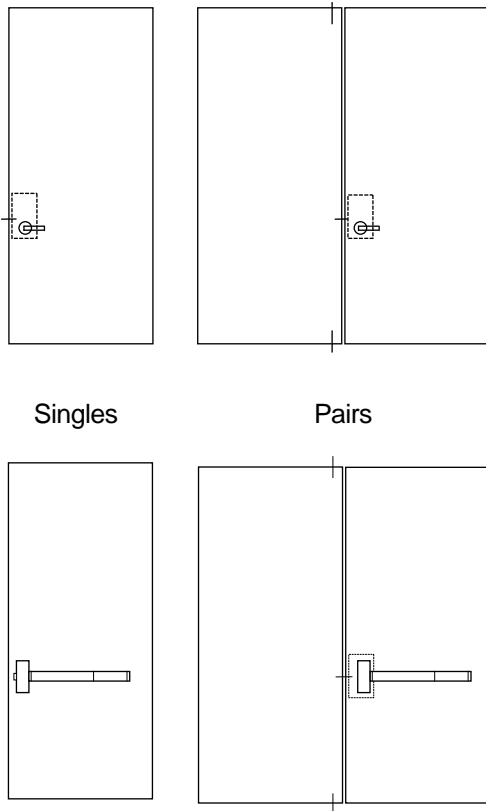

### Product:

1¾" (44 mm) thick doors, swinging singly or in pairs, up to 3 hour *fire-protection rating* and temperature-rise rating (TRR) of 250°F (121°C) at 30 minutes<sup>(B)</sup>.

The TRR is in addition to the *fire-protection rating*. It indicates the code required maximum temperature-rise above ambient, developed on the unexposed face of the door at the 30 minute point of a fire test. The governing building code dictates the level of protection required for openings in specific locations.

The IBC may require TRR *fire doors for interior exit stairways, ramps and exit passageways* <sup>[16]</sup>. In some applications they may be required for *fire doors* installed in *fire walls* and *stairways* of multi-storey buildings.

The 2012 IBC specifies only 450°F (232°C) TRR's. However, earlier IBC editions also included 250°F (121°C) and 650°F (361°C).

### Maximum Door Opening:

|                    |                              |                            |
|--------------------|------------------------------|----------------------------|
| 3 Hour:            | Singles : 250°, 450°, 650°F: | 4' x 8' (1219 x 2438 mm)   |
|                    | : 450°, 650°F:               | 4' x 10' (1219 x 3048 mm)  |
| Pairs :            | 250°, 450°, 650°F:           | 8' x 8' (2438 x 2438 mm)   |
|                    | : 450°, 650°F:               | 8' x 10' (2438 x 3048 mm)  |
| 1½ Hour: Singles : | 250°, 450°, 650°F:           | 4' x 10' (1219 x 3048 mm)  |
|                    | : 450°, 650°F:               | 5' x 12' (1524 x 3658 mm)  |
| Pairs :            | 250°, 450°, 650°F:           | 8' x 10' (2438 x 3048 mm)  |
|                    | : 450°, 650°F:               | 10' x 12' (3048 x 3658 mm) |

Note: Pairs may be provided without an over-lapping *astragal*

### Glazing:

TRR doors are permitted with *labeled fire-protection rated glazing materials* with exposed sizes not exceeding 100 in<sup>2</sup> (0.065m<sup>2</sup>) per door up to 1½ hour rating. For sizes exceeding the above, *labeled fire-resistance rated glazing materials* that are additionally *listed* and *labeled as fire-protection rated glazing materials* for TRR to the sizes and ratings in their individual *listings* are permitted. The 2012 IBC does not permit *glazing materials* in 3 hour *fire doors*.

### Louvers:

Louvers are not permitted in TRR doors

### Frames:

Any *fire-protection rated frame* may be used. Codes do not permit glazed *transom or sidelight assemblies* in TRR openings <sup>[14]</sup>.

### Specifications:

Refer to ANSI/NAAMM HMMA 860, 861 or 867 for detailed specifications or consult individual [member companies](#).

### Maximum Leaf Size:

|          |              |                           |
|----------|--------------|---------------------------|
| 3 Hour:  | 250°F:       | 4' x 8' (1219 x 2438 mm)  |
|          | 450°, 650°F: | 4' x 10' (1219 x 3048 mm) |
| 1½ Hour: | 250°F:       | 4' x 10' (1219 x 3048 mm) |
|          | 450°, 650°F: | 5' x 12' (1524 x 3658 mm) |

### Hardware:

Refer to [Section 2](#) for detailed requirements and Page 2-6 for Hardware Code Summary

| Hardware                           | Nominal Door Sizes                                      |   |
|------------------------------------|---|---|
|                                    | Not Exceeding 4'0" (1219) Width and 10'0" (3048) Height | Over 4'0" (1219) up to 5'0" (1524) Width or Over 10'0" (3048) up to 12'0" (3658) Height |
| Hinges                             | H1 to H15   | H1 to H5 & H7 to H14  |
| Offset Pivots                      | H16 & H17   | Not Permitted   |
| Locks and Latches                  | L1, L2 & L3   | L1  |
| Minimum Latch Throw <sup>(A)</sup> |   |   |
| - Singles : 8' ht and less         | ½" (12.7 mm)  | ¾" (19 mm)  |
| : Over 8' ht                       | ¾" (19 mm)  | ¾" (19 mm)  |
| - Pairs                            | ¾" (19 mm)  | ¾" (19 mm)  |
| Deadbolts                          | L4 & L5   | L4 & L5   |
| Fire Exit Hardware - Singles       | FEH1 & FEH2   | Not Permitted   |
| - Pairs                            | FEH1 & FEH2   | Not Permitted   |
| Overhead Closers                   | C1 to C6  | C1 to C6  |
| Floor Closers                      | C7 & C8   | Not Permitted   |
| Flush Bolts                        | FB1 to FB4  | FB1 to FB4  |

See Page 3-3 for additional size, gage and hardware specific information.

### Notes

(A): Unless otherwise indicated in individual door manufacturer's *listings*

(B): Other applications and constructions, such as *Double Egress* pairs are available. Contact individual [member manufacturers](#) for additional information.

## DOUBLE EGRESS HOLLOW METAL FIRE DOORS AND FRAMES

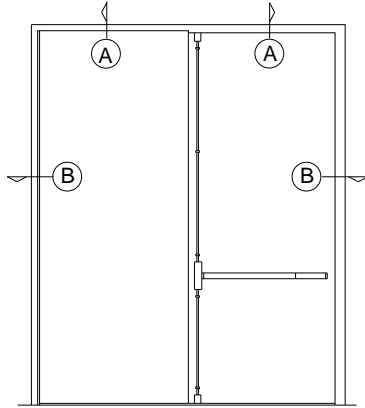

Typical Elevations

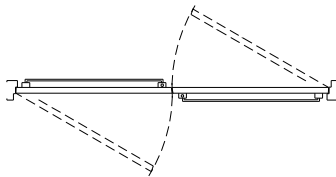
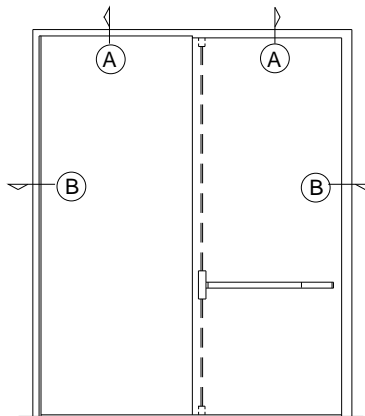

Typical Plan View

### Product:

1 $\frac{3}{4}$ " (44 mm) thick pairs of doors swinging in opposite directions, up to 3 hour *fire-protection rating*.<sup>(B)</sup>

*Double egress* assemblies permit traffic flow in both directions through the same opening. *Double egress* doors may be provided without over-lapping *astragals*.

### Maximum Door Opening:

8'0" x 10'0" (2438 x 3048 mm)

### Maximum Leaf Size:

4'0" x 10'0" (1219 x 3048 mm)

### Hardware:

Refer to [Section 2](#) for detailed requirements and Page [2-6](#) for Hardware Code Summary

### Hinges:

H1 to H5, H7 to H15

### Offset Pivots:

H16 and H17

### Locks, Latches, Deadbolts:

Not Permitted

### Fire Exit Hardware:

FEH3 and FEH4 only<sup>(A)</sup>

### Overhead Closers:

C1 to C6

### Floor Closers:

C7 and C8

### Flush Bolts:

Not Permitted

See Page [3-3](#) for additional size and gage specific information

### Glazing:

Refer to Section 1, [Table 3](#), Page 1-14 for requirements

### Louvers:

Not permitted

### Anchors:

*Anchors* are available for new or existing masonry, poured concrete and wood or steel stud partitions. See "*Anchors for Fire-Protection Rated Frames*", Page [3-29](#) for additional information.

### Frames:

*Fire-protection rated frame product labeled for use with double egress doors* is required.

### Specifications:

Refer to ANSI/NAAMM HMMA [860](#), [861](#), [866](#) or [867](#) for detailed specifications or consult individual [member companies](#).

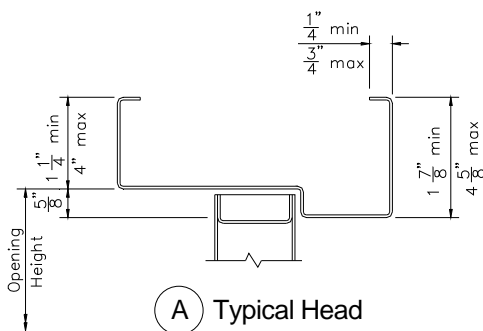

(A) Typical Head

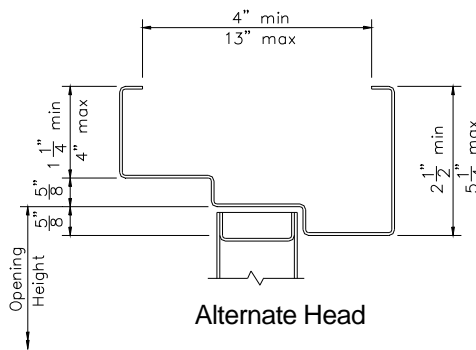

Alternate Head

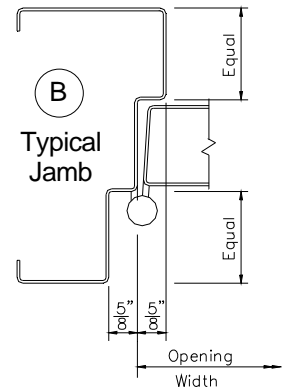

(B) Typical Jamb

### Notes:

(A) : Both leaves are required for *exit* purposes, therefore they must be provided with *labeled* surface (FEH3) or *concealed* (FEH4) vertical rod *fire exit hardware*. There are no exceptions to this for *double egress* door and frame assemblies.

(B): Other applications or configurations are available. Contact individual [member manufacturers](#) for additional information.

## STAINLESS STEEL FIRE DOORS

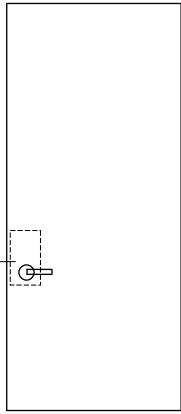

Singles

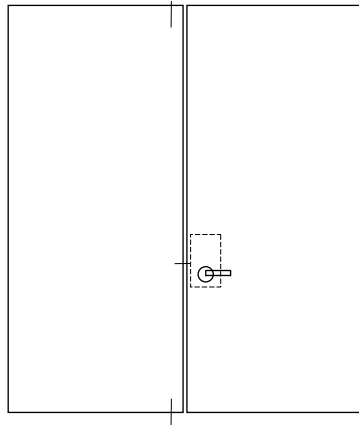

Pairs

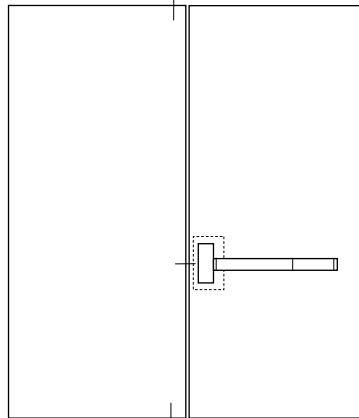
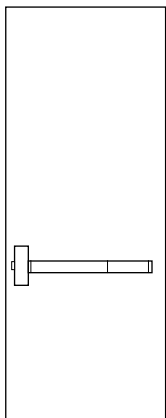

### Product:

1¾" (44 mm) thick stainless steel doors, swinging singly or in pairs, up to 3 hour *fire-protection rating*. Available in Types 304, 316 or 430 stainless steel.<sup>(B)</sup>

### Maximum Door Opening:

Type 304 or 316: Singles: 4'0" x 8'0" (1219 x 2438 mm)  
 Pairs: 8'0" x 8'0" (2438 x 2438 mm)  
 Type 430: Singles: 4'0" x 10'0" (1219 x 3048 mm)  
 Pairs: 8'0" x 10'0" (2438 x 3048 mm)

Note: Pairs may be provided without an over-lapping *astragal* in ratings up to 1½ hour. For 3 hour rated pairs an over-lapping *astragal* is required.

### Maximum Leaf Size:

Type 304 or 316: 4'0" x 8'0" (1219 x 2438 mm)  
 Type 430: 4'0" x 10'0" (1219 x 3048 mm)

### Hardware:

Refer to [Section 2](#) for detailed requirements and Page 2-6 for Hardware Code Summary

|                                     |                   |
|-------------------------------------|-------------------|
| Hinges:                             | H1 to H15         |
| Offset Pivots:                      | H16 and H17       |
| Locks, Latches, Deadbolts:          | L1, L2, L4 and L5 |
| Minimum Latch Throw <sup>(A)</sup>  |                   |
| Singles: 8'0" ht and less:          | ½" (12.7 mm)      |
| Over 8'0" height:                   | ¾" (19 mm)        |
| Pairs:                              | ¾" (19 mm)        |
| <i>Fire Exit Hardware:</i> Singles: | FEH1 and FEH2     |
| Pairs:                              | FEH1 to FEH4      |
| <i>Overhead Closers:</i>            | C1 and C3         |
| <i>Floor Closers:</i>               | Not Permitted     |
| <i>Flush Bolts:</i>                 | FB1 to FB4        |

See Page 3-3 for additional size, gage and hardware specific information

### Glazing:

Consult individual [member companies](#) for requirements

### Frames:

Any *fire-protection rated* frame product may be used.

### Specifications:

Refer to ANSI/NAAMM HMMA 866 for detailed specifications or consult individual [member companies](#).

### Notes:

(A): Unless indicated otherwise in individual door manufacturer's *listings*

(B): Other applications are available. Contact individual [member manufacturers](#) for additional information.

## DUTCH HOLLOW METAL FIRE DOORS

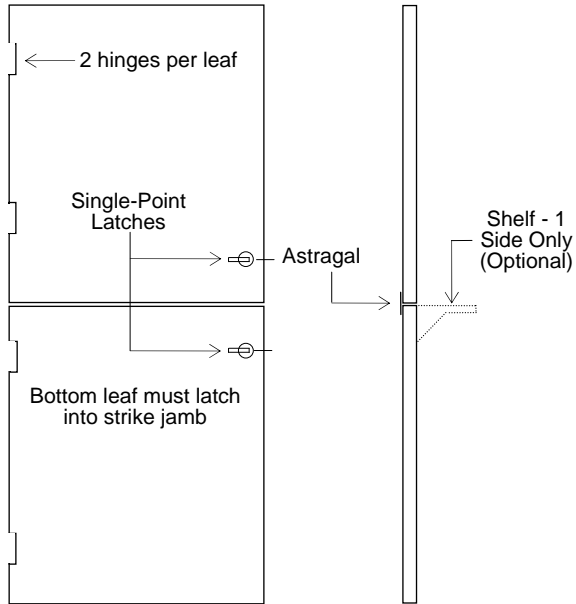

Top Leaf Latching into Strike Jamb

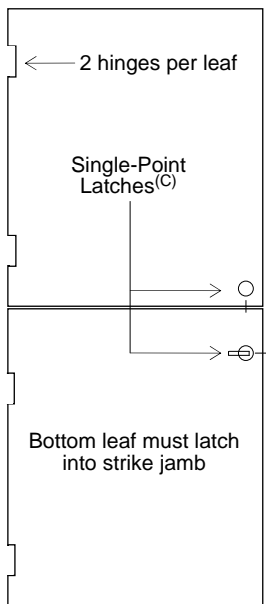

Top Leaf Latching into Bottom Leaf

### Product:

1¼" (44 mm) thick, single swing *dutch door*, with top leaf mounted over-lapping *astragal*, with or without optional shelf, up to 3 hour *fire-protection rating*.

### Maximum Door Opening:

4'0" x 8'0" (1219 x 2438 mm)

### Hardware:

Refer to [Section 2](#) for detailed requirements and Page [2-6](#) for Hardware Code Summary

### Hinges:

H1 to H15

### Offset Pivots:

Not Permitted

### Locks, Latches, Deadbolts<sup>(A)</sup>:

L1 and L2

### Minimum Latch Throw:

½"

### Fire Exit Hardware:

Not Permitted

### Overhead Closers:

C1 to C6, top leaf only

### Floor Closers:

Not Permitted

### Flush Bolts:

FB4<sup>(B)</sup>

### Glazing:

Consult individual [member companies](#) for requirements

### Louvers:

Not permitted

### Frames:

Any *fire-protection rated frame* or *transom frame* may be used.

### Specifications:

Refer to ANSI/NAAMM HMMA [860](#), [861](#) or [867](#) for detailed specifications or consult individual [member companies](#).

### Notes:

(A): Each leaf must be provided with an active latch bolt.

(B): *Labeled automatic flush bolt* may be provided for top leaf (in lieu of *single-point latch*) when top leaf latches into bottom leaf.

## LOUVERED HOLLOW METAL FIRE DOORS

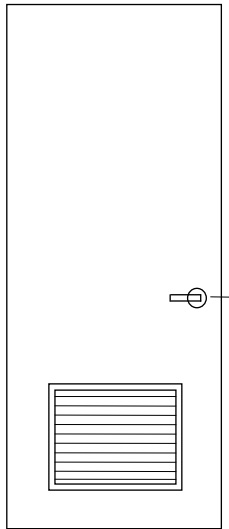

Singles

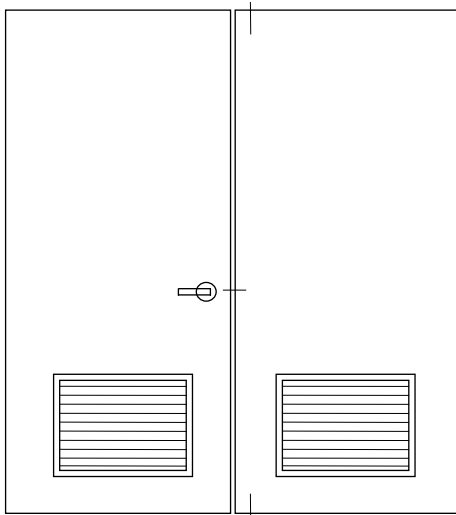

Pairs

### Product:

1 $\frac{3}{4}$ " (44 mm) thick doors, swinging singly or in pairs, equipped with *labeled fire door* louvers, up to 1 $\frac{1}{2}$  hour *fire-protection rating*.<sup>(B)</sup> Louvers are not permitted in glazed, *double egress*, *dutch*,  $\frac{1}{3}$  hour, temperature-rise rated, a *means of egress*, *smoke control* <sup>[11,15]</sup> or Factory Mutual *labeled doors*.

### Louvers:

Maximum louver size: 24" x 24" (610 x 610 mm) per leaf. Louvers are permitted in the bottom 40" (1016 mm) of doors only. Only *labeled fire door* louvers may be used <sup>[80]</sup>.

### Maximum Door Opening:

Singles: 4'0" x 10'0" (1219 x 3048 mm)

Pairs: 8'0" x 10'0" (2438 x 3048 mm)

Note: Pairs may be provided without an over-lapping *astragal*.

### Maximum Leaf Size:

4'0" x 10'0" (1219 x 3048 mm)

### Hardware:

Refer to [Section 2](#) for detailed requirements and Page [2-6](#) for Hardware Code Summary

|  |                           |
|--|---------------------------|
| Hinges:                                    | H1 to H15                 |
| Offset Pivots:                             | H16 and H17               |
| Locks, Latches, Deadbolts:                 | L1, L2 and L3             |
| Minimum Latch Throw <sup>(A)</sup> :       |                           |
| Singles : 8'0" ht and less:                | $\frac{1}{2}$ " (12.7 mm) |
| : Over 8'0" ht:                            | $\frac{3}{4}$ " (19 mm)   |
| Pairs:                                     | $\frac{3}{4}$ " (19 mm)   |
| <i>Fire Exit Hardware</i> <sup>(C)</sup> : |                           |
| Singles:                                   | FEH1 and FEH2             |
| Pairs:                                     | FEH1 to FEH4              |
| Overhead <i>Closers</i> :                  | C1 to C6                  |
| Floor <i>Closers</i> :                     | C7 and C8                 |
| <i>Flush Bolts</i> :                       | FB1 to FB4                |

See Page [3-4](#) for additional size, gage and hardware specific information

### Glazing:

Not permitted

### Frames:

Any *fire-protection rated* frame product may be used.

### Specifications:

Refer to ANSI/NAAMM HMMA [860](#), [861](#) or [867](#) for detailed specifications or consult individual [member companies](#).

### Notes:

(A): Unless indicated otherwise in individual door manufacturer's *listings*.

(B): Other applications and constructions are available. Contact individual [member manufacturers](#) for additional information.

(C): Where acceptable to the *AHJ*

## THREE-SIDED FIRE DOOR FRAMES

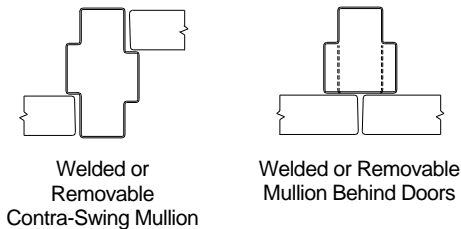
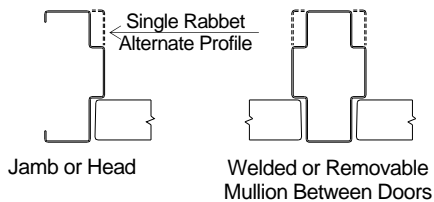
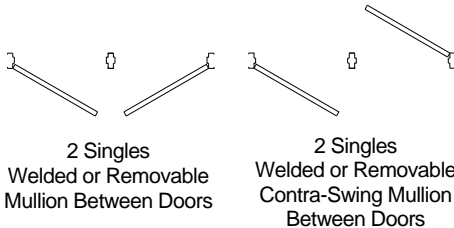
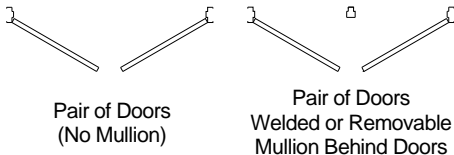
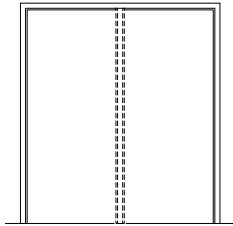
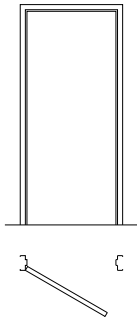

### Product:

3 hour (maximum) *fire door frames* used with 1¾" (44 mm) thick *fire doors* swinging singly or in pairs including 2-piece *rough buck* and split frames.

### Maximum Door Opening:

3 Hour: Singles: Welded or *KD*: 4'0" x 10'0" (1219 x 3048 mm)  
 Pairs: Welded or *KD*: 8'0" x 10'0" (2438 x 3048 mm)

### Mild<sup>(A)</sup> and Type 430 Stainless Steel:

1½ Hour: Singles: Welded: 5'0" x 12'0" (1524 x 3658 mm)  
 Slip-On: 4'0" x 9'0" (1219 x 2743 mm)  
*KD* Split: 4'0" x 8'0" (1219 x 2438 mm)  
 Pairs: Welded: 10'0" x 12'0" (3048 x 3658 mm)  
 Slip-On: 8'0" x 8'10" (2438 x 2692 mm)  
 Contra-Swing: Welded: 4'0" x 8'0" (1219 x 2438 mm)

### Maximum Leaf Size:

3 Hour: Singles and Pairs  
 Welded or *KD*: 4'0" x 10'0" (1219 x 3048 mm)

### Mild<sup>(A)</sup> and Type 430 Stainless Steel:

1½ Hour: Singles and Pairs  
 Welded: 5'0" x 12'0" (1524 x 3658 mm)  
*KD* Split: 4'0" x 8'0" (1219 x 2438 mm)  
 Slip-On: Singles: 4'0" x 9'0" (1219 x 2743 mm)  
 Pairs: 4'0" x 8'10" (1219 x 2692 mm)  
 Contra-Swing: Welded: 4'0" x 8'0" (1219 x 2438 mm)

See Page 3-5 for additional size and gage specific information

### Mullions:

*Mullions* are optional and may be welded or removable for either between or behind the door applications. Mild steel<sup>(A)</sup> removable *mullions* are permitted in welded or *knocked-down* frames only up to 8' x 8' (2438 x 2438 mm) at 3 hour rating. Doors cannot be hinged off removable *mullions*.

### Anchors:

*Anchors* for welded or *knocked-down* frames are available for new or existing masonry, poured concrete, structural steel, wood and steel stud partitions. Slip-on frames are provided with *anchors* for wood or steel stud partitions. See "Anchors for Fire Door Frame Product", Page 3-29 for additional information.

### Specifications:

Frames may be fabricated from hot rolled, cold rolled, galvanized, galvanized or stainless steel. Refer to ANSI/NAAMM HMMA 860, 861, 866 or 867 for detailed specifications or consult individual member companies.

### Profiles:

Single or double rabbet jambs, heads and *mullions*. See "Profiles for Fire Door Frame Product", Page 3-28 for additional information.

(A): Includes hot rolled, cold rolled, galvanized and galvanized steel



## MULTIPLE OPENING FRAMES

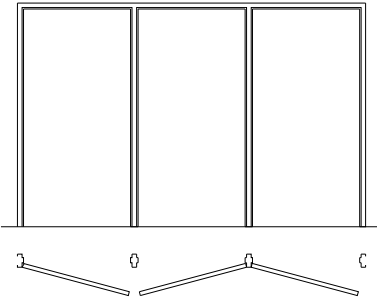

### Product:

1½ hour (maximum) welded *fire door frames* used with 1¾" (44 mm) thick *fire doors*, swinging in combinations of singles, pairs, contra-swing and/or *double egress* configurations.

### Maximum Door Opening:

Singles and Contra-Swing: 4'0" x 8'0" (1219 x 2438 mm)  
 Pairs and *Double Egress*: 8'0" x 8'0" (2438 x 2438 mm)

### Maximum Leaf Size:

4'0" x 8'0" (1219 x 2438 mm)

### Maximum Over-All Unit Width:

12'10" (3912 mm)

### Mullions:

Hollow metal *mullions* may be welded or removable for either between or behind the door applications. Doors cannot be hinged off removable *mullions*.

### Anchors:

*Anchors* are available for new or existing masonry, poured concrete, structural steel, wood and steel stud partitions. See "Anchors for Fire Door Frame Product", Page 3-29 for additional information.

### Specifications:

Frames may be fabricated from hot rolled, cold rolled, galvanized or galvanized steel. Refer to ANSI/NAAMM HMMA 860, 861 or 867 for detailed specifications or consult individual [member companies](#).

### Profiles:

Single or double rabbet jambs, heads and *mullions*. See "Profiles for Fire Door Frame Product", Page 3-28 for additional information.

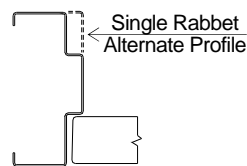
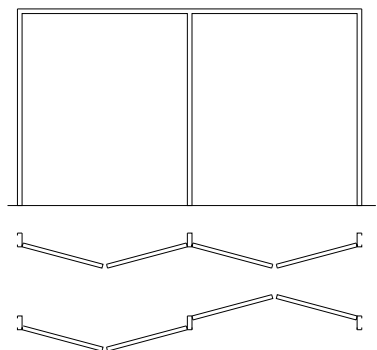
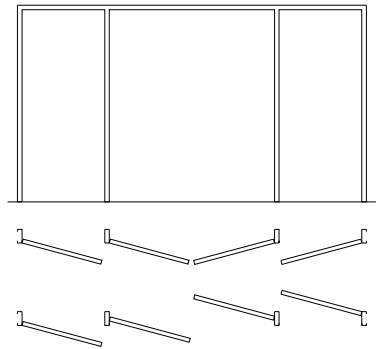
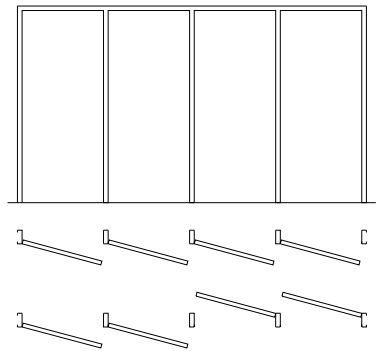

Jamb or Head

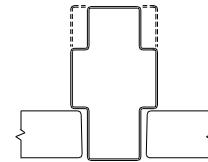

Welded or Removable Mullion Between Doors

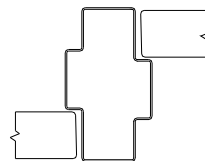

Welded or Removable Contra-Swing Mullion

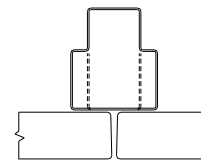

Welded or Removable Mullion Behind Doors

## FRAMES WITH 1¾" (44 mm) TRANSOM PANELS WITHOUT TRANSOM MULLION

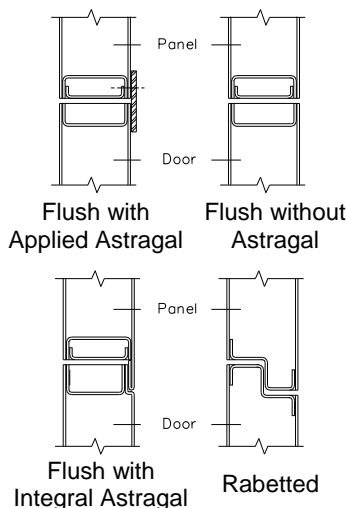
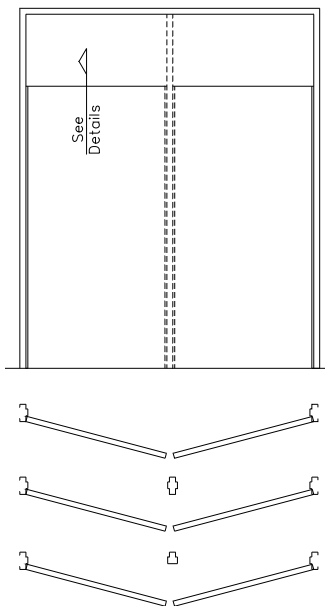
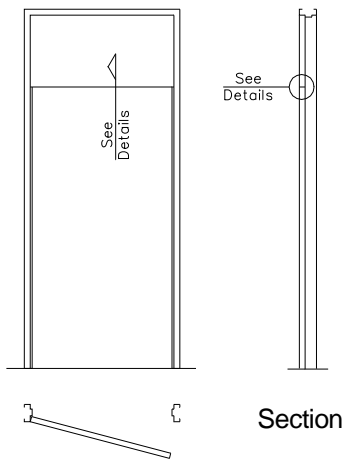

### Product:

3 hour (maximum) welded or *knocked-down*<sup>(A)</sup> fire door frame and 1¾" (44 mm) thick welded or removable *panel* used with 1¾" (44 mm) thick *fire doors* swinging singly or in pairs.

Note: Flush *panel* may be provided without applied over-lapping *astragal* in ratings up to 1½ hour. 3 hour rated *panels* must be flush with applied or integral *astragal* or rabbed.

### Maximum Combined Door and *Panel* Opening Height:

|          |                    |                 |
|----------|--------------------|-----------------|
| 3 Hour:  | Singles and Pairs: | 11'2" (3404 mm) |
| 1½ Hour: | Singles:           | 12'0" (3658 mm) |
|          | Pairs:             | 11'2" (3404 mm) |

### Maximum Leaf Size:

|          |                              |
|----------|------------------------------|
| 3 Hour:  | 4'0" x 9'0" (1219 x 2743 mm) |
| 1½ Hour: | 4'0" x 9'6" (1219 x 2896 mm) |

### Maximum Panel Size:

|          |                              |
|----------|------------------------------|
| Singles: | 4'0" x 4'6" (1219 x 1372 mm) |
| Pairs:   | 8'0" x 4'0" (2438 x 1219 mm) |

See Page 3-5 for additional size, gage and material specific information

Note: The most common application for this type of frame utilizes a head above the *panel*. However, frames are available where the jambs are terminated at the top of the *panel* and a head is not required.

### Vertical Mullions:

Welded vertical *mullions* for between or behind the door applications are permitted.

### Anchors:

*Anchors* are available for new or existing masonry, poured concrete, structural steel, wood and steel studs partitions. See "Anchors for Fire Door Frame Product", Page 3-29 for additional information.

### Hardware:

*Flush bolts* (FB2 to FB4) required on *inactive leaf* of pairs. *Fire exit hardware* when *approved* for use with *transom panels*.

### Specifications:

Frame and *panel* may be fabricated from hot rolled, cold rolled, galvanized or galvanized steel. For all other design and construction requirements consult individual [member companies](#).

### Profiles:

Single or double rabbet jambs, heads and vertical *mullions*. See "Profiles for Fire Door Frame Product", Page 3-28 for additional information.

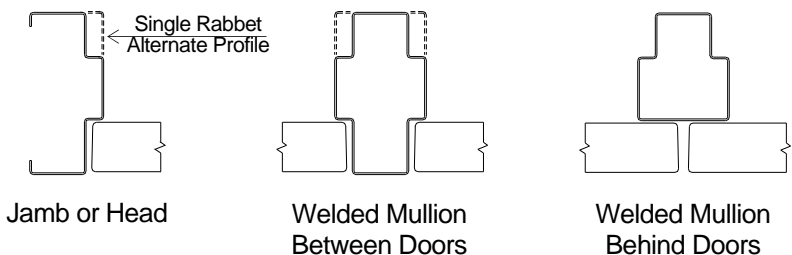

(A): 2 singles with *mullion* between doors available as welded frame only.

## TRANSOM FRAMES WITH 1 3/4" (44 mm) TRANSOM PANELS AND TRANSOM MULLION

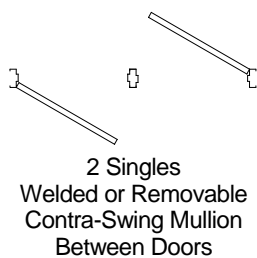
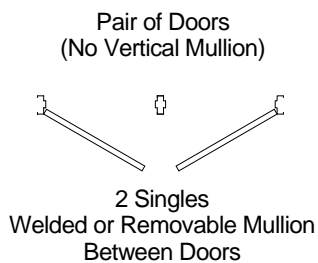
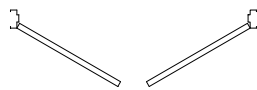
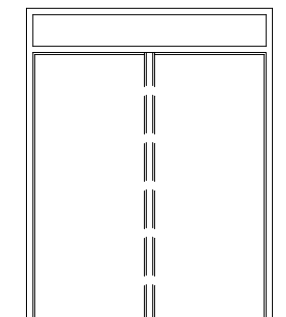
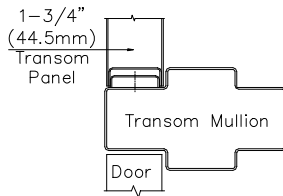
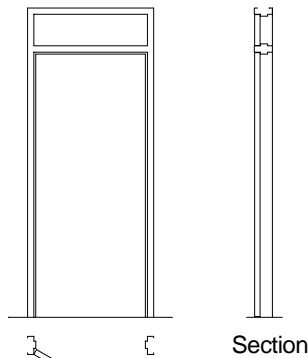

### Product:

3 hour (maximum) welded *fire door transom frames* with 1 3/4" (44 mm) thick welded or removable *transom panels* used with 1 3/4" (44 mm) thick *fire doors* swinging singly, in pairs or contra-swing.

### Maximum Combined Door, Mullion and Transom Opening Height:

3 Hour: 11'2" (3404 mm)

1 1/2 Hour: 12'0" (3658 mm)

### Maximum Leaf Size:

3 Hour: Singles and Pairs: 4'0" x 10'0" (1219 x 3048 mm)

1 1/2 Hour: Singles and Pairs: 5'0" x 11'6"<sup>(B)</sup> (1524 x 3353 mm)

Contra-Swing: 4'0" x 8'0" (1219 x 2438 mm)

### Maximum Transom Panel Size:

3 Hour: Singles: 4'0" x 4'0" (1219 x 1219 mm)

Pairs: 8'0" x 4'0" (2438 x 1219 mm)

1 1/2 Hour: Singles: 5'0" x 4'0" (1524 x 1219 mm)

Pairs: 10'0" x 4'0" (3048 x 1219 mm)

Contra-Swing: 8'0" x 4'0" (2438 x 1219 mm)

See Page 3-5 for additional size, gage and material specific information

### Transom Material:

*Transom panels* may be fabricated from hot rolled, cold rolled, galvanized, galvanized or stainless steel.

Louvers are not permitted in *transom* openings <sup>[64]</sup>.

### Mullions:

Horizontal *transom mullion* may be welded or removable. Mild steel<sup>(A)</sup> removable horizontal *transom mullions* permitted above 8' (2438mm) wide door openings maximum. Vertical *mullions* for between and behind door applications are optional and may be welded or removable. Mild steel<sup>(A)</sup> removable vertical *mullions* permitted for door openings up to 8' (2438 mm) height. Removable vertical *mullions* are permitted with welded or removable *transom mullions*. Doors cannot be hinged off removable *mullions*.

### Anchors:

*Anchors* are available for new or existing masonry, poured concrete, structural steel, wood and steel stud partitions. See "Anchors for Fire Door Frame Product", Page 3-29 for additional information.

### Specifications:

*Transom* frames may be fabricated from hot rolled, cold rolled, galvanized, galvanized or stainless steel. Refer to ANSI/NAAMM HMMA 860, 861, 866 or 867 for detailed specifications or consult individual [member companies](#).

### Profiles:

Single or double rabbet jambs, heads and *mullions*. See "Profiles for Fire Door Frame Product", Page 3-28 for additional information.

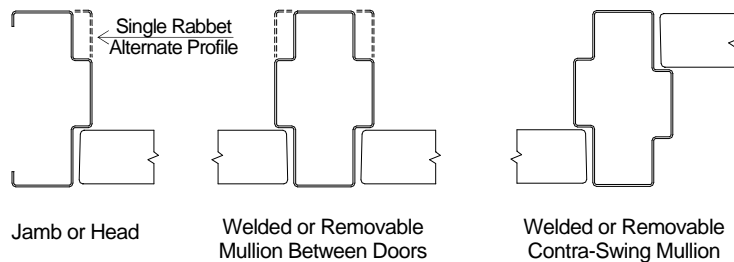

(A): Includes hot rolled, cold rolled, galvanized and galvanized steel

(B): Based on 1 1/4" (31.8 mm) minimum face transom mullion and 3/4" (120.7 mm) minimum transom opening height

## TRANSOM FRAMES WITH TRANSOM PANELS AND TRANSOM MULLIONS

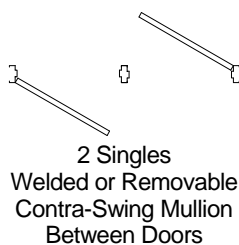
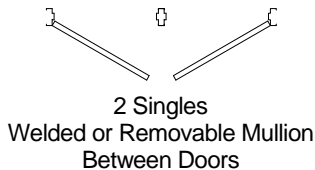
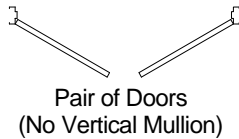
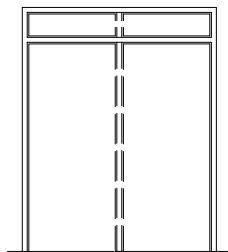
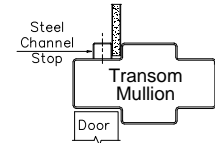
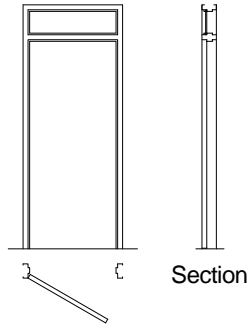

### Product:

3 hour (maximum) welded *fire door transom frames* with steel-faced  $\frac{3}{8}$ " to  $\frac{3}{4}$ " (9.5 to 19.1 mm) thick *transom panels* used with  $1\frac{3}{4}$ " (44 mm) thick *fire doors* swinging singly, in pairs, contra-swing or *double egress* configurations.

### Maximum Combined Door, Mullion and Transom Opening Height:

3 Hour: 10'0" (3048 mm)  
1½ Hour: 12'0" (3658 mm)

### Maximum Leaf Size:

|          |  |                             |                  |
|----------|--|-----------------------------|------------------|
| 3 Hour:  | Singles, Pairs and<br><i>Double Egress</i> : | 4'0" x 9'6" <sup>(B)</sup>  | (1219 x 2896 mm) |
| 1½ Hour: | Singles and Pairs:<br><i>Double Egress</i> : | 5'0" x 11'6" <sup>(B)</sup> | (1524 x 3353 mm) |
|          | <i>Contra-Swing</i> :                        | 4'0" x 8'0"                 | (1219 x 2438 mm) |

### Maximum Transom Panel Size:

|          |  |              |                  |
|----------|--|--------------|------------------|
| 3 Hour:  | Singles:   | 4'0" x 4'0"  | (1219 x 1219 mm) |
|          | Pairs, <i>Double Egress</i><br>and <i>Contra-Swing</i> : | 8'0" x 4'0"  | (2438 x 1219 mm) |
| 1½ Hour: | Singles:   | 5'0" x 4'0"  | (1524 x 1219 mm) |
|          | Pairs:   | 10'0" x 4'0" | (3048 x 1219 mm) |
|          | <i>Double Egress</i> and<br><i>Contra-Swing</i> :        | 8'0" x 4'0"  | (2438 x 1219 mm) |

See Page 3-5 for additional size, gage and material specific information

### Transom Material:

Minimum 0.032" (0.8 mm) thick hot rolled, cold rolled, galvanized, galvanized or stainless steel laminated to each face of an *approved* core. Louvers are not permitted in *transom* openings <sup>[64]</sup>.

### Mullions:

Horizontal *transom mullions* may be welded or removable. Mild steel<sup>(A)</sup> removable horizontal *transom mullions* permitted above 8' (2438mm) wide door openings maximum. Vertical *mullions* for between and behind door applications are optional and may be welded or removable. Mild steel<sup>(A)</sup> removable vertical *mullions* permitted for door openings up to 8' (2438 mm) height. Removable vertical *mullions* are permitted with welded or removable *transom mullions*. Doors cannot be hinged off removable *mullions*. Vertical *transom mullions* must be welded.

### Anchors:

*Anchors* are available for new or existing masonry, poured concrete, structural steel, wood and steel stud partitions. See "Anchors for Fire Door Frame Product", Page 3-29 for additional information.

### Specifications:

*Transom* frames may be fabricated from hot rolled, cold rolled, galvanized, galvanized or stainless steel. Refer to ANSI/NAAMM HMMA 860, 861, 866 or 867 for detailed specifications or consult individual [member companies](#).

### Profiles:

Single or double rabbet jambs, heads and *mullions*. See "Profiles for Fire Door Frame Product", Page 3-28 for additional information.

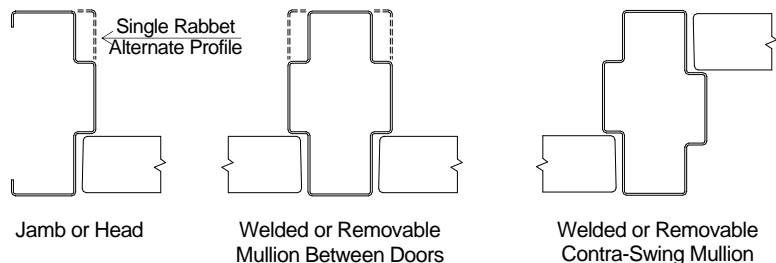

(A): Includes hot rolled, cold rolled, galvanized and galvanized steel

(B): Based on  $1\frac{1}{4}$ " (31.8 mm) minimum face transom mullion and  $\frac{3}{4}$ " (120.7 mm) minimum transom opening height

## TRANSOM FRAMES - GLAZED

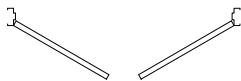
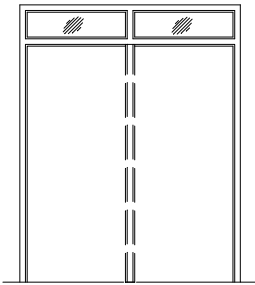
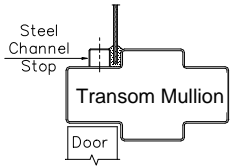
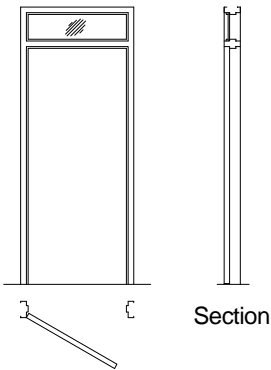

Pair of Doors  
(No Vertical Mullion)

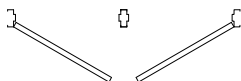

2 Singles  
Welded or Removable Mullion  
Between Doors

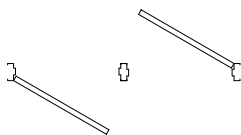

2 Singles  
Welded or Removable  
Contra-Swing Mullion  
Between Doors

### Product:

Welded fire door transom frames for labeled glazing materials used with 1¼" (44 mm) thick fire doors swinging singly, in pairs, contra-swing or double egress configurations. Transoms with labeled wired glazing provide up to a ¾ hour fire rating. With specific labeled laminated or non-wired glazing materials, transom frames are available up to 1½ hour fire-protection rating. Refer to glazing manufacturer's listings for additional information.

**Maximum Combined Door, Mullion and Transom Opening Height:**  
12'0" (3658 mm)

### Maximum Leaf Size:

Singles and Pairs: 5'0" x 11'6"<sup>(B)</sup> (1524 x 3353 mm)  
Double Egress: 4'0" x 10'0" (1219 x 3048 mm)  
Contra-Swing: 4'0" x 8'0" (1219 x 2438 mm)

See Page 3-5 for additional size, gage and material specific information

### Glazing:

Refer to Section 1, Table 4, Page 1-15 for materials, requirements and options.

Louvers are not permitted in transom openings <sup>[64]</sup>.

### Mullions:

Horizontal transom mullion may be welded or removable. Mild steel<sup>(A)</sup> removable horizontal transom mullions permitted above 8' (2438mm) wide door openings maximum. Vertical mullions for between and behind door applications are optional and may be welded or removable. Mild steel<sup>(A)</sup> removable vertical mullions permitted for door openings up to 8' (2438 mm) height. Removable vertical mullions are permitted with welded or removable transom mullions. Doors cannot be hinged off removable mullions. Vertical transom mullions must be welded.

### Anchors:

Anchors are available for new or existing masonry, poured concrete, structural steel, wood and steel stud partitions. See "Anchors for Fire Door Frame Product", Page 3-29 for additional information.

### Specifications:

Transom frames may be fabricated from hot rolled, cold rolled, galvanized, galvannealed or stainless steel. Refer to ANSI/NAAMM HMMA 860, 861, 866 or 867 for detailed specifications or consult individual member companies.

### Profiles:

Single or double rabbet jambs, heads and mullions. See "Profiles for Fire Door Frame Product", Page 3-28 for additional information.

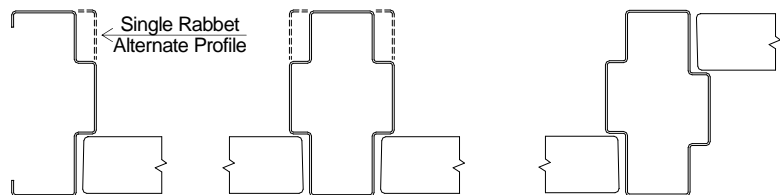

Jamb or Head

Welded or Removable  
Mullion Between Doors

Welded or Removable  
Contra-Swing Mullion

(A): Includes hot rolled, cold rolled, galvanneal and galvanized steel

(B): Based on 1¼" (31.8 mm) minimum face transom mullion and ¾" (120.7 mm) minimum transom opening height

## MULTIPLE OPENING TRANSOM FRAMES - GLAZED OR paneled

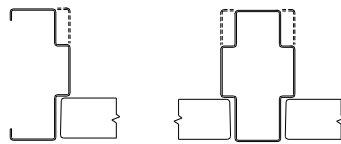
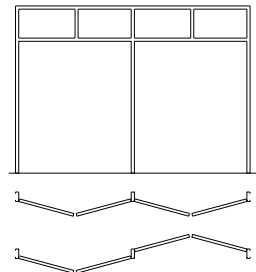
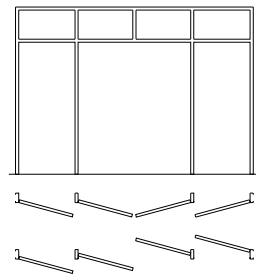
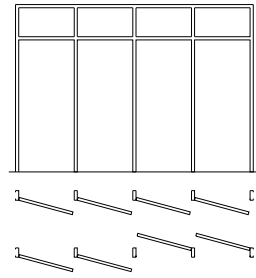
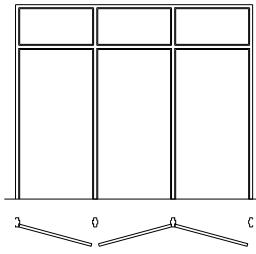

Jamb  
or Head

Welded or  
Rem Mull  
Between Doors

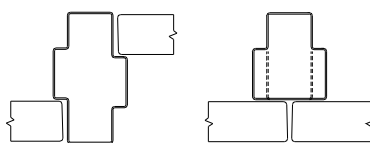

Welded or Rem  
Contra-Swing  
Mullion

Welded or  
Rem Mull  
Behind Doors

### Product:

1½ hour (maximum) welded *fire door transom frames* with 1¾" (44.4 mm) thick welded or removable *transom panels*, steel-faced ⅝" to ¾" (9.5 to 19.1 mm) *transom panels* or specific *labeled glazing materials*, used with 1¾" (44 mm) thick *fire doors*, swinging in combinations of singles, pairs, contra-swing and/or *double egress* configurations. *Transoms with labeled wired glazing* provide up to a ¾ hour fire rating. With specific *labeled laminated or non-wired glazing materials*, multi-opening *transom frames* are available up to 1½ hour *fire-protection rating*. Refer to *glazing manufacturer's listings* for additional information.

### Maximum Over-All Unit Size: (Width x Height)

Drywall Partitions: 1½ Hr: 12'10" x 10'0" (3912 x 3048 mm)

¾ Hr: 12'10" x 11'4" (3912 x 3454 mm)

All Other Partitions: 1½ Hr: 12'10" x 12'0" (3912 x 3658 mm)

¾ Hr: 13'6" x 12'0" (4115 x 3658 mm)

### Maximum Door Opening:

Singles and Contra-Swing: 4'0" x 8'0" (1219 x 2438 mm)

Pairs and *Double Egress*: 8'0" x 8'0" (2438 x 2438 mm)

### Maximum Leaf Size:

4'0" x 8'0" (1219 x 2438 mm)

### Maximum Transom Panel Size:

Singles and Contra-Swing: 4'0" x 4'0" (1219 x 1219 mm)

Pairs and *Double Egress*: 8'0" x 4'0" (2438 x 1219 mm)

### Transom Material:

Minimum 0.032" (0.8 mm) thick hot rolled, cold rolled, galvanized, galvanized or Type 430 stainless steel laminated to each face of an *approved core*.

### Glazing:

Refer to Section 1, [Table 4](#), Page 1-15 for materials, requirements and options.

Louvers are not permitted in *transom* openings <sup>[64]</sup>.

### Mullions:

Horizontal and vertical *transom mullions* may be welded or removable. Removable horizontal *transom mullions* permitted above 8' (2438mm) wide door openings maximum. Vertical *mullions* at doors may be welded or removable for either between or behind door applications. Removable vertical *mullions* permitted for door openings up to 8' (2438 mm) height. Removable vertical *mullions* are permitted with welded or removable *transom mullions*. Doors cannot be hinged off removable *mullions*.

### Anchors:

*Anchors* are available for new or existing masonry, poured concrete, structural steel, wood and steel stud partitions See "Anchors for Fire Door Frame Product", Page [3-29](#) for additional information.

### Specifications:

Frames may be fabricated from hot rolled, cold rolled, galvanized or galvanized steel. Refer to ANSI/NAAMM HMMA [860](#), [861](#) or [867](#) for detailed specifications or consult individual [member companies](#).

### Profiles:

Single or double rabbet jambs, heads and *mullions*. See "Profiles for Fire Door Frame Product", Page [3-28](#) for additional information.

## SIDLIGHT AND WINDOW FRAMES - GLAZED OR paneled

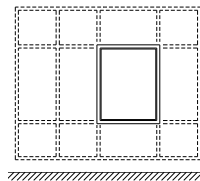
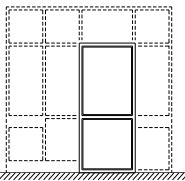
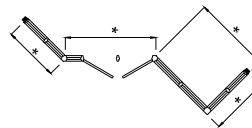
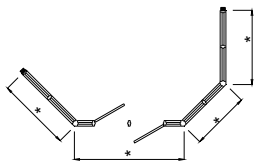
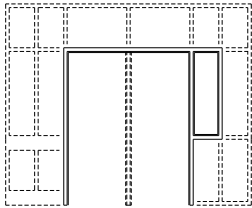
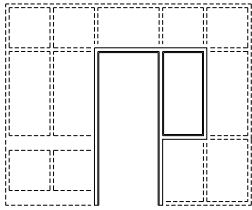

Floor Mounted  
Fire Window

Knee Wall Mounted  
Fire Window

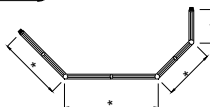
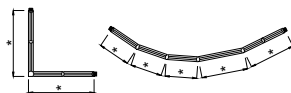

### Notes:

- (A): Codes [3.6.7] may limit the maximum area and / or percentage of wall length/area.  
 (B): Includes hot rolled, cold rolled, galvanized and galvanized steel.  
 (C): Maximum single glazed opening sizes indicated. No vertical or horizontal *mullions* are permitted. Contact individual [member manufacturers](#) for detailed glazing and size information.

### Product:

Welded fire door frame with side panels and/or lights and optional transom panels and/or lights, used with 1¾" (44 mm) thick fire doors, swinging singly, in pairs, contra-swing or double egress configurations.

Welded or slip-on fire window frames with fixed openings and labeled glazing materials and/or panels. Fire windows may be mounted directly on the floor or on knee wall partitions.

Sidelights and windows with labeled wired glazing provide a maximum ¾ hour fire-protection rating. With specific labeled laminated or non-wired glazing materials and/or panels, sidelights and windows are available up to 1½ hour fire-protection rating. Refer to glazing manufacturer's listings for additional information.

Segmented mild<sup>(B)</sup> or 430 stainless steel sidelight and window frames, ¾ hour rating maximum, in all partition types may incorporate 2, 3 or 4-way vertical hollow metal corner posts.

Field splices are permitted in ¾ hour rated (maximum) sidelight and window frames and may be used in conjunction with vertical hollow metal corner posts and segmented units.

### Maximum Over-All Unit Size<sup>(A)</sup>:

Mild<sup>(B)</sup> & Type 430 Stainless Steel: 13'6" x 12'0" (4115 x 3658 mm)

Type 304 & 316 Stainless Steel: 9'4" x 10'0" (2845 x 3048 mm)

Slip-On Windows<sup>(B,C)</sup>: 7'11" x 7'11" (2413 x 2413 mm)

Individual 'segment lengths' (shown as \* on the plan views at left) may not exceed the over-all unit widths defined above.<sup>(A)</sup>

### Maximum Door Opening:

Mild<sup>(B)</sup> and Type 430 Stainless Steel:

Singles: 4'0" x 10'0" (1219 x 3048 mm)

Pairs and Double Egress: 8'0" x 10'0" (2438 x 3048 mm)

Contra-Swing: 8'0" x 8'0" (2438 x 2438 mm)

Type 304 and 316 Stainless Steel:

Singles and Contra-Swing: 4'0" x 8'0" (1219 x 2438 mm)

Pairs and Double Egress: 8'0" x 8'0" (2438 x 2438 mm)

### Maximum Leaf Size:

Mild<sup>(B)</sup> and Type 430 Stainless Steel:

Singles, Pairs

and Double Egress: 4'0" x 10'0" (1219 x 3048 mm)

Contra-Swing: 4'0" x 8'0" (1219 x 2438 mm)

Type 304 and 316 Stainless Steel:

Singles, Pairs, Double

Egress and Contra-Swing: 4'0" x 8'0" (1219 x 2438 mm)

### Maximum Individual Panel Size:

#### Sidelight Frames:

Transom: 8'0" x 4'0" (2438 x 1219 mm)

Side: 8'0" width, 8'0" height, 4608 in<sup>2</sup> area  
(2438 mm, 2438 mm, 2.97 m<sup>2</sup>)

Window Frames: 8'0" width, 8'0" height, 4608 in<sup>2</sup> area  
(2438 mm, 2438 mm, 2.97 m<sup>2</sup>)

See Page 3-6 for additional size, gage and material specific information

## SIDELIGHT AND WINDOW FRAMES - GLAZED OR PANELED (continued)

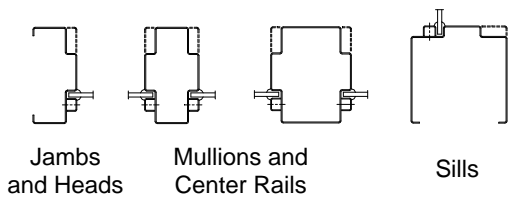

Jamb and Heads

Mullions and Center Rails

Sills

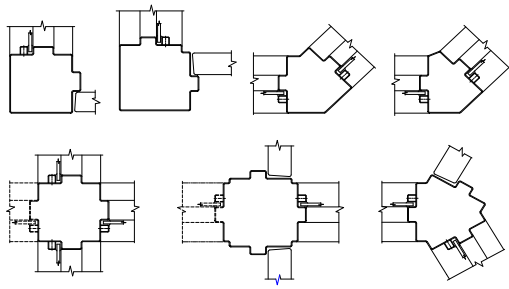

Typical Vertical Hollow Metal Corner Posts for Sidelight and Window Frames

### Panel Material:

Minimum 0.032" (0.8 mm) thick hot rolled, cold rolled, galvanized, galvanized or stainless steel laminated to each face of an *approved* core.

### Glazing:

Refer to Section 1, [Table 4](#), Page 1-15 for materials, requirements and options.

Louvers are not permitted, except in door openings <sup>[64]</sup>

### Mullions:

Vertical *mullions* for between the door applications are optional and may be welded or removable. Mild steel<sup>(B)</sup> removable vertical *mullions* permitted for door openings up to 8' (2438 mm) height. Removable vertical *mullions* are permitted with welded or removable *transom mullions*. Horizontal *transom mullions* (immediately above doors) may be welded or removable. Mild steel<sup>(B)</sup> removable horizontal *mullion* permitted above 8' (2438 mm) wide door openings maximum. All other *mullions* must be welded. Doors cannot be hinged off removable *mullions*.

### Anchors:

*Anchors* are available for new or existing masonry, poured concrete, structural steel, wood and steel stud partitions. See "Anchors for Fire Door Frame Product", Page [3-29](#) for additional information.

### Specifications:

*Sidelight and window frames* may be fabricated from hot rolled, cold rolled, galvanized, galvanized or stainless steel. Refer to ANSI/NAAMM HMMA [860](#), [861](#), [866](#) or [867](#) for detailed specifications or consult individual [member companies](#).

### Profiles:

Single or double rabbet jambs, heads, *mullions*, sills and corner posts. *Mullions* (not surrounding doors) center rails and sills may be recessed from perimeter members. See "Profiles for Fire Door Frame Product", Page [3-28](#) for additional information.



## SOUND CONTROL HOLLOW METAL DOOR AND FRAME ASSEMBLIES

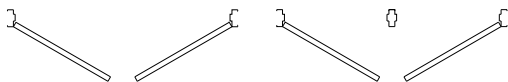
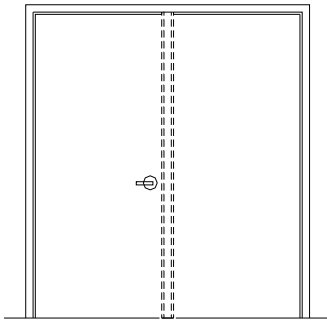
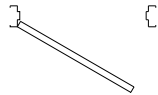
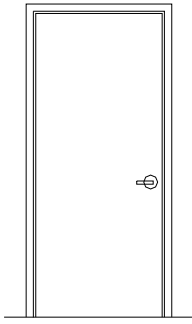

Pair of Doors  
(No Vertical Mullion)

2 Singles  
Welded Mullion  
Between Doors

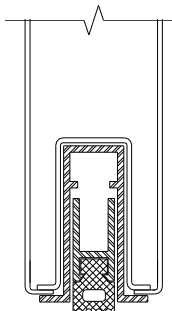

Door Bottom Detail  
(Varies with manufacturer)

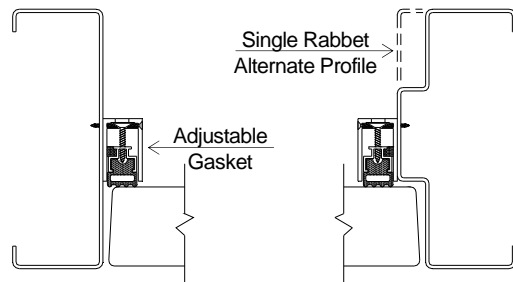

Jamb or Head Detail  
(Gasketing varies with manufacturer)

### Product:

3 hour (maximum) sound control *fire door and frame assembly* with 1¾" (44 mm) (minimum) thick doors, swinging singly or in pairs. Doors, frame and sound seals must be provided as a complete assembly.

Assemblies are rated for Sound Transmission Class (STC), Outdoor-Indoor Transmission Class (OITC) or Sound Transmission Loss (STL). Air borne sound transmission loss is measured in accordance with [ASTM E90](#). The STC is determined by the procedures set forth in [ASTM E413](#) or the OITC by those in [ASTM E1332](#).

### Maximum Door Opening:

Singles: 4'0" x 8'0" (1219 x 2438 mm)

Pairs: 8'0" x 8'0" (2438 x 2438 mm)

### Maximum Leaf Size:

4'0" x 8'0" (1219 x 2438 mm)

### Hardware:

Consult individual [member companies](#) for details

### Glazing:

3 hour: *Glazing not permitted*

1½ hour: 100 in<sup>2</sup> (0.065m<sup>2</sup>) glass light per leaf

¾ hour: 300 in<sup>2</sup> (0.194m<sup>2</sup>) glass light per leaf

Contact individual [member companies](#) for additional details

### Mullions:

Welded *mullions* for between the door applications are optional.

### Anchors:

*Anchors* are available for new or existing masonry, poured concrete, structural steel, wood and steel stud partitions. See "Anchors for Fire Door Frame Product", Page [3-29](#) for additional information.

### Specifications:

Assemblies may be fabricated from hot rolled, cold rolled, galvanized or galvanized steel. Refer to ANSI/NAAMM HMMA [865](#) for detailed specifications or consult individual [member companies](#).

### Profiles:

Cased open, single or double rabbet jambs, heads and *mullions* with applied adjustable gasketing. See "Profiles for Fire Door Frame Product", Page [3-28](#) for additional information.

# COMMERCIAL SECURITY HOLLOW METAL DOOR AND FRAME ASSEMBLIES

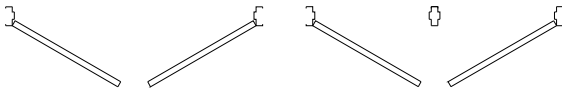
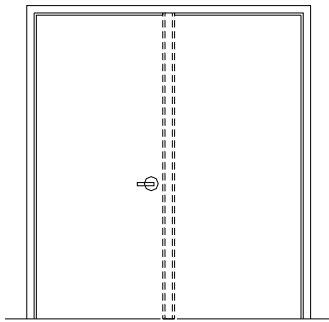
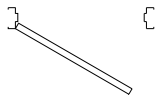
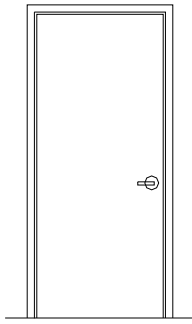

Pair of Doors  
(No Vertical Mullion)

2 Singles  
Welded Mullion  
Between Doors

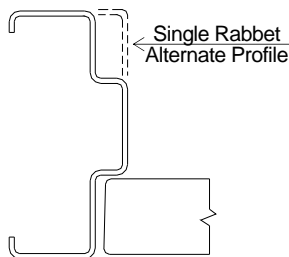

Door Mounted Lock  
Strike Jamb, Hinge  
Jamb or Head

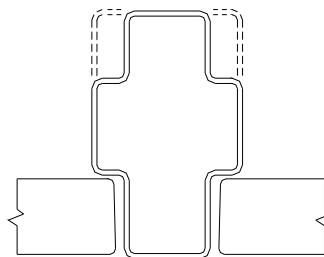

Welded Mullion  
Between Doors

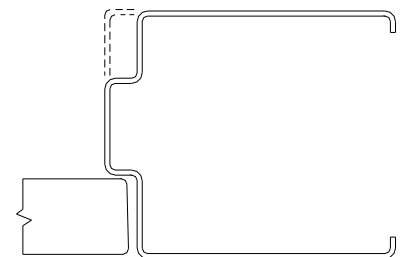

Jamb Mounted Lock  
Strike Jamb

## Product:

3 hour (maximum) commercial security *fire door and frame assembly* with 1¾" (44 mm) (minimum) thick doors, swinging singly or in pairs or sliding singly, for use in facilities where a high degree of security is required. Commercial security assemblies must comply with one or more of the test procedures in [ASTM F1450](#), [ASTM F1592](#), SD-STD-01.01 Rev. G (1993) or LPS 1175: Issue 5 (2000), and the acceptance criteria of ANSI/NAAMM HMMA [862](#). In addition these products are available with bullet-resistant capabilities meeting ANSI/UL [752](#).

## Maximum Door Opening:

Singles - Swinging or Sliding: 4'0" x 8'0" (1219 x 2438 mm)  
Pairs - Swinging: 8'0" x 8'0" (2438 x 2438 mm)

## Maximum Leaf Size:

4'0" x 8'0" (1219 x 2438 mm)

## Hardware:

Consult individual [member companies](#) for details

## Glazing:

Consult individual [member companies](#) for details

## Mullions:

Welded *mullions* for between the door applications are optional.

## Anchors:

*Anchors* are available for new or existing masonry or poured concrete partitions. See "Anchors for Fire Door Frame Product", Page [3-29](#) for additional information.

## Specifications:

Assemblies may be fabricated from hot rolled, cold rolled, galvanized, galvanized or stainless steel. Refer to ANSI/NAAMM HMMA [862](#) for detailed specifications or consult individual [member companies](#).

## Profiles:

Single and double rabbet jambs, heads and *mullions*. See "Profiles for Fire Door Frame Product", Page [3-28](#) for additional information.

## DETENTION SECURITY HOLLOW METAL DOOR AND FRAME ASSEMBLIES

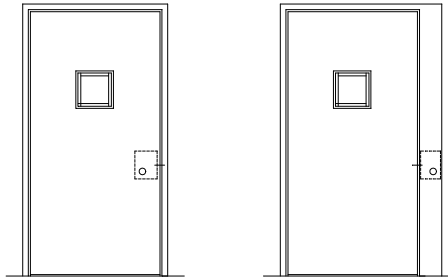

Single  
Door Mounted Lock

Single  
Jamb Mounted Lock

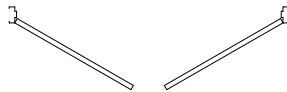
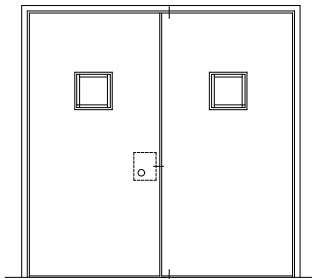

Pair of Doors  
(No Mullion)  
Door Mounted Lock

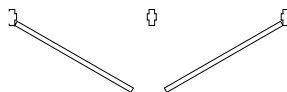

2 Singles  
Welded Mullion Between Doors  
Door Mounted Lock

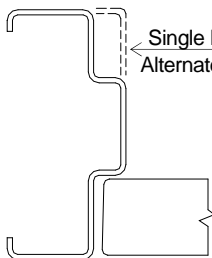

Door Mounted Lock  
Strike Jamb, Hinge  
Jamb or Head

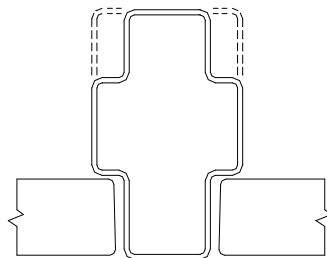

Welded Mullion  
Between Doors

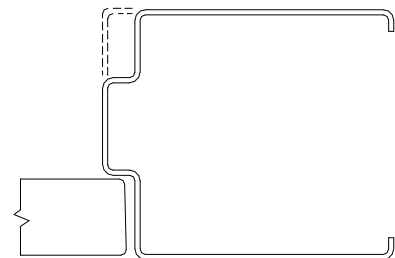

Jamb Mounted Lock  
Strike Jamb

### Product:

3 hour (maximum) detention security *fire door and frame assembly* with 2" (50.8 mm) (minimum) thick doors, swinging singly or in pairs or sliding singly, for use in detention and correctional facilities and other buildings where a high degree of security is required. Detention security assemblies must comply with [ASTM F1450](#) and [ASTM F1592](#) test procedures and the acceptance criteria of ANSI/NAAMM HMMA [863](#) for impact resistance, static load, rack, edge crush and removable *glazing* stop requirements. In addition these products are available with bullet-resistant capabilities meeting ANSI/UL [752](#).

### Maximum Door Opening:

Singles - Swinging or Sliding: 4'0" x 8'0" (1219 x 2438 mm)  
Pairs - Swinging: 8'0" x 8'0" (2438 x 2438 mm)

### Maximum Leaf Size:

4'0" x 8'0" (1219 x 2438 mm)

### Hardware:

Consult individual [member companies](#) for details

### Glazing:

Refer to Section 1, [Table 3](#), Page 1-14 for door requirements and options.

### Mullions:

Welded *mullions* for between the door applications are optional.

### Anchors:

*Anchors* are available for new or existing masonry or poured concrete partitions. See "Anchors for Fire Door Frame Product", Page [3-29](#) for additional information.

### Specifications:

Assemblies may be fabricated from hot rolled, cold rolled, galvanized, galvanized or stainless steel. Refer to ANSI/NAAMM HMMA [863](#) for detailed specifications or consult individual [member companies](#).

### Profiles:

Single and double rabbet jambs, heads and *mullions*. See "Profiles for Fire Door Frame Product", Page [3-28](#) for additional information.

## BULLET-RESISTANT HOLLOW METAL DOOR AND FRAME ASSEMBLIES

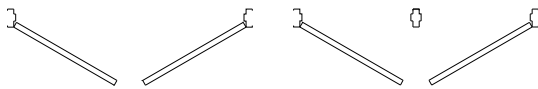
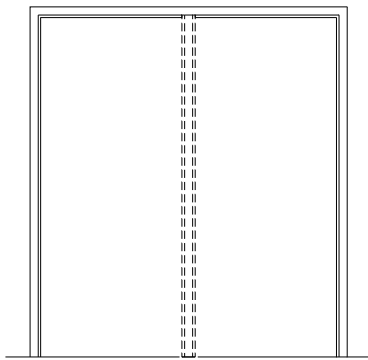
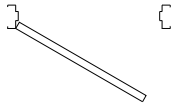
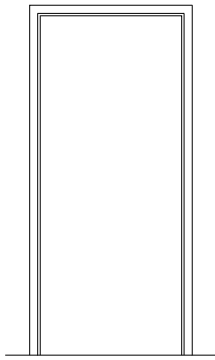

Pair of Doors  
(No Vertical Mullion)

2 Singles  
Welded Mullion  
Between Doors

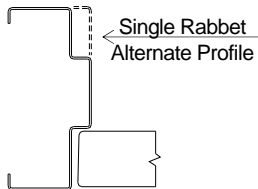

Jamb or Head

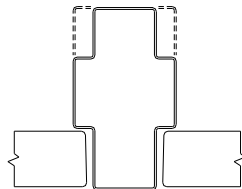

Mullion

### Product:

3 hour (maximum) bullet-resistant *fire door and frame assembly* with 1¾" (44 mm) (minimum) thick doors, swinging singly or in pairs, intended to form bullet-resistant barriers which protect against robbery or holdup.

These are specialized door and frame assemblies providing protection from medium (9 mm) through super power (.44 Magnum) hand guns, high power (30-06) rifles, military munitions (308 Winchester rifle) or multiple shots from submachine guns (9 mm Uzi) up to military assault rifles. These assemblies have been tested to the requirements of ANSI/UL 752, "Bullet-Resisting Equipment".

There are 8 rating levels with Level 1 for medium power hand guns up to Level 8 for 7.62 mm assault rifles. A supplementary category for 12 gage shot guns with rifled lead slug and 00 lead buckshot is also available. Assemblies meeting the additional shot gun requirements have a suffix "SG" added to the rating designation.

### Maximum Door Opening:

Singles: 4'0" x 10'0" (1219 x 3048 mm)

Pairs: 8'0" x 10'0" (2438 x 3048 mm)

### Maximum Leaf Size:

4'0" x 10'0" (1219 x 3048 mm)

See Page 3-6 for additional size, gage and material specific information

### Hardware:

Consult individual [member companies](#) for details

### Glazing:

Consult individual [member companies](#) for details

### Mullions:

Welded *mullions* for between the door applications are optional.

### Anchors:

*Anchors* are available for new or existing masonry, poured concrete, structural steel, wood and steel stud partitions. See "Anchors for Fire Door Frame Product", Page 3-29 for additional information.

### Specifications:

Assemblies may be fabricated from hot rolled, cold rolled, galvanized, galvanized or stainless steel. For all other design and construction features consult individual [member companies](#).

### Profiles:

Single and double rabbet jambs, heads and *mullions*. See "Profiles for Fire Door Frame Product", Page 3-28 for additional information.

## RADIATION SHIELDING HOLLOW METAL DOOR AND FRAME ASSEMBLIES

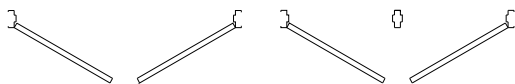
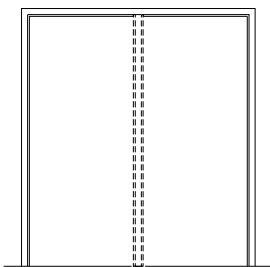
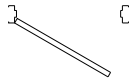
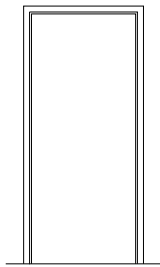

Pair of Doors  
(No Vertical Mullion)

2 Singles  
Welded Mullion  
Between Doors

### Product:

3 hour (maximum) radiation shielding door and frame assembly with 1 $\frac{3}{4}$ " (44 mm) thick doors swinging singly or in pairs used to provide shielding against x-rays and other forms of radiation which could be injurious to humans, other forms of life or material.

These assemblies are designed to specification to provide shielding against specific types and intensities of radiation.

### Maximum Door Opening:

Singles: 4'0" x 8'0" (1219 x 2438 mm)

Pairs: 8'0" x 8'0" (2438 x 2438 mm)

### Maximum Leaf Size:

4'0" x 8'0" (1219 x 2438 mm)

### Hardware:

Consult individual [member companies](#) for details

### Glazing:

Refer to Section 1, [Table 3](#), Page 1-14 for requirements.

### Mullions:

Welded *mullions* for between the door applications are optional.

### Anchors:

*Anchors* are available for new or existing masonry, poured concrete, structural steel, wood and steel stud partitions. See "Anchors for Fire Door Frame Product", Page [3-29](#) for additional information.

### Specifications:

Assemblies may be fabricated from hot rolled, cold rolled, galvanized, galvanized or stainless steel. For all other design and construction features consult individual [member companies](#).

### Profiles:

Single or double rabbet jambs, heads and *mullions*. See "Profiles for Fire Door Frame Product", Page [3-28](#) for additional information.

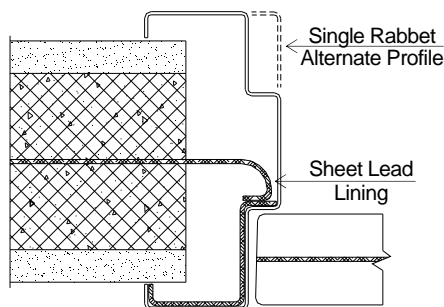

Jamb or Head

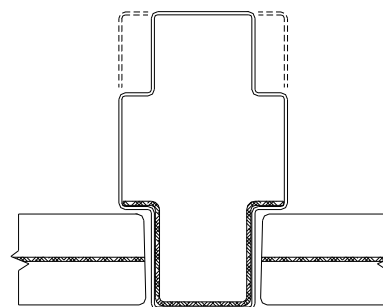

Mullion

## PROFILES FOR FIRE DOOR FRAME PRODUCT

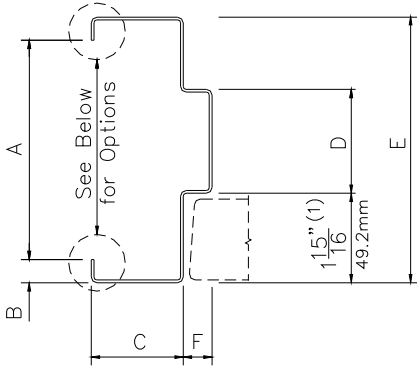

| Double Rabbet Jambs, Heads and Sills |  |               |                              |                 |                  |               |
|--------------------------------------|--|---------------|------------------------------|-----------------|------------------|---------------|
|                                      | A  | B             | C                            | D               | E                | F             |
|                                      | Throat                                       | Return        | Face                         | Soffit          | Jamb Depth       | Stop          |
| Min                                  | 2¼" <sup>(3)</sup><br>57.1 mm <sup>(3)</sup> | 0             | 1" <sup>(2)</sup><br>25.4 mm | 3/16"<br>4.8 mm | 2¾"<br>60.3 mm   | ⅝"<br>15.9 mm |
| Max                                  | 13"<br>330.2 mm                              | ¾"<br>19.1 mm | 12"<br>304.8 mm              | -               | 14½"<br>368.3 mm | -             |

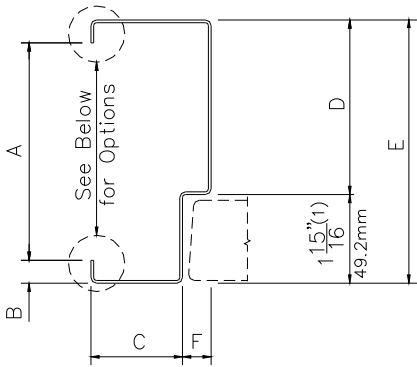

| Single Rabbet Jambs, Heads and Sills |   |               |                              |                 |                  |               |
|--------------------------------------|---|---------------|------------------------------|-----------------|------------------|---------------|
|                                      | A   | B             | C                            | D               | E                | F             |
|                                      | Throat                                      | Return        | Face                         | Soffit          | Jamb Depth       | Stop          |
| Min                                  | 2" <sup>(3)</sup><br>50.8 mm <sup>(3)</sup> | 0             | 1" <sup>(2)</sup><br>25.4 mm | 3/16"<br>4.8 mm | 2⅝"<br>60 mm     | ⅝"<br>15.9 mm |
| Max                                  | 13"<br>330.2 mm                             | ¾"<br>19.1 mm | 12"<br>304.8 mm              | -               | 14½"<br>368.3 mm | -             |

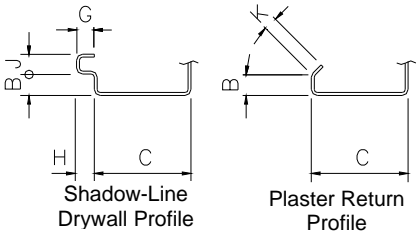
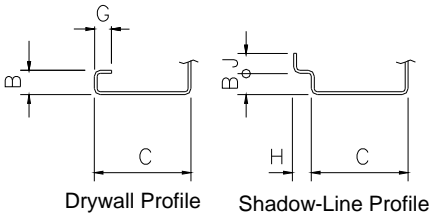

| Profile Options for Jambs, Heads and Sills <sup>(4)</sup> |               |                              |               |                |               |                   |
|---|---------------|------------------------------|---------------|----------------|---------------|-------------------|
|   | B             | C                            | G             | H              | J             | K                 |
|   | Return        | Face                         | Back Bend     | Reveal Flange  | Reveal Return | Plaster Back Bend |
| Min   | ¼"<br>6.3 mm  | 1" <sup>(2)</sup><br>25.4 mm | ¼"<br>6.3 mm  | ¼"<br>6.3 mm   | ¼"<br>6.3 mm  | ¼"<br>6.3 mm      |
| Max   | ¾"<br>19.1 mm | 12"<br>304.8 mm              | ¾"<br>19.1 mm | 4"<br>101.6 mm | ¾"<br>19.1 mm | ¾"<br>19.1 mm     |

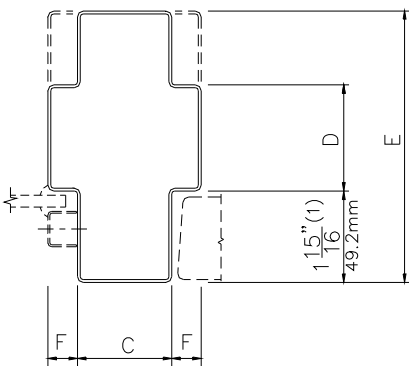

| Single or Double Rabbet Mullions, Center Rails & Corner Posts |                              |               |                  |               |
|---|------------------------------|---------------|------------------|---------------|
|   | C                            | D             | E                | F             |
|   | Face                         | Soffit        | Jamb Depth       | Stop          |
| Min   | 1" <sup>(2)</sup><br>25.4 mm | 1"<br>25.4 mm | 4½"<br>114.3 mm  | ⅝"<br>15.9 mm |
| Max   | 12"<br>304.8 mm              | -             | 10½"<br>266.7 mm | -             |

- (1): To suit 1¾" (44 mm) doors
- (2): For 3-sided frames in masonry or concrete partitions and surrounding glazed openings in *sidelight* or *window frames*. ¼" (31.8 mm) minimum at all frames in stud walls, all *transom frames* and surrounding door openings in *sidelight frames*.
- (3): Larger dimensions may be required to suit specific wall types
- (4): May be specified for one or both sides of profile

## ANCHORS FOR FIRE DOOR FRAME PRODUCT

### Wall Anchors - General:

Each jamb of the frame product must be provided with *anchors* to suit the wall construction to which the jamb is to be fastened. Jamb in the same frame product may be provided with *anchors* to suit different wall types (ie: unit masonry at one, steel stud partition at the other). Frame product can only be anchored to a wall and may not be anchored to an adjacent frame product, glazed block assembly, wall grille, diffuser or louver <sup>[55,85]</sup>.

All *anchors* used in the installation of *fire-protection rated frame product* must be included in the Follow-Up Service (FUS) procedures or Factory Audit Manuals (FAM) of the original product manufacturer, as *approved* and issued by the certifier.

Each *anchor* is located immediately above or below the hinge reinforcing on the hinge jamb and directly opposite on the *strike* jamb as shown in Figure 6.

Unless *listed* otherwise welded and *knocked-down fire-protection rated* frame products require two *anchors* for each jamb up to 5'0" (1524 mm) and an additional *anchor* for each additional 2'6" (762 mm) of height or fraction thereof.

Grout, when used in accordance with industry guidelines, may improve frame durability, sound deadening and, depending on wall construction, increase frame anchorage strength. Grouting a frame does not increase door durability and is not required to maintain the *fire-protection rating* of frame product. For most commercial applications grouting of *mullions*, other closed sections and frames in wood or steel stud partitions is not recommended. See HMMA's Tech Note, "Grouting Hollow Metal Frames", [HMMA-820 TN01-03](#), for additional information.

For welded and *knocked-down* frame product in stud partitions HMMA recommends that one additional *anchor* be provided for each jamb over the number of *anchors* required for masonry openings of equivalent height.

*Approved anchors* similar to those shown on these pages, [HMMA 840](#), "Guide Specifications for Installation and Storage of Hollow Metal Doors and Frames" and referenced in NAAMM-HMMA's [860 Series](#) Guide Specifications, may be used with *fire-protection rated* frame product.

### Masonry Anchors:

Figures 7A, 7B and 7C illustrate masonry *anchors approved* for welded and *knocked-down fire-protection rated* frame product. The stirrup of the Strap and Stirrup type is welded to the back of the jamb soffit. This type of *anchor* can be used in either masonry or poured concrete construction. The T-Strap and Wire Loop types are shipped loose. Each type provides sufficient adjustment for masonry coursing as well as access for full grouting of jamba. These *anchors* are eligible for use in frame product rated up to 3 hours.

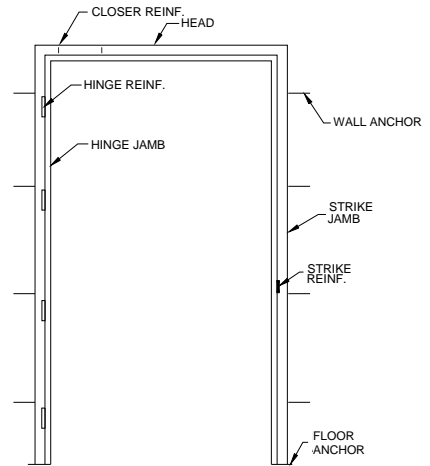

SINGLE UNIT TYPE  
PRESSED STEEL FRAME  
FIGURE 6

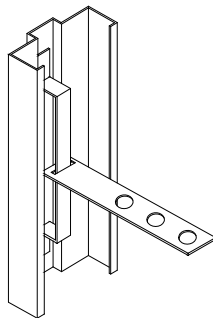

STRAP AND STIRRUP ANCHOR  
FIGURE 7A

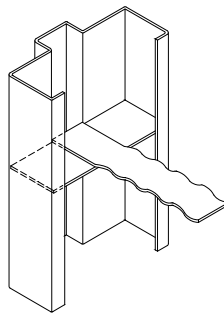

T-STRAP ANCHOR  
FIGURE 7B

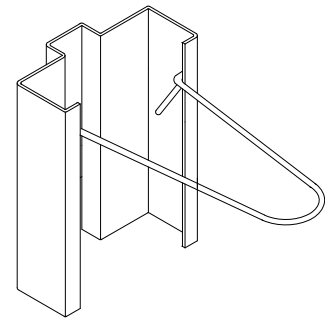

WIRE LOOP ANCHOR  
FIGURE 7C

**Steel Stud Anchors:**

Figure 8A illustrates a steel stud *anchor* which is welded to the back of the jamb and attached to the steel stud by welding or mechanical fasteners. Figure 8B shows a steel stud *anchor* which may be welded or friction fitted inside the jamb profile. Both are eligible for use in welded and *knocked-down* frames up to 3 hour rating. Figures 8C and 8D are for welded frame product up to 1½ hour rating, end-butteted in steel stud partitions. Figure 8C illustrates new steel stud partition applications, and Figure 8D, existing partitions. For new steel stud applications (Figure 8C) *anchors* are welded to the back of each jamb 6" (152 mm) from each end and at 24" (610 mm) on center (maximum) and secured to the stud by welding or mechanical fasteners. For existing steel stud installations (Figure 8D) *anchors* are welded in jambs and heads pierced and dimpled for ¼" (6 mm) diameter sheet metal screws not more than 6" (152 mm) from each end and 24" (610 mm) on center maximum.

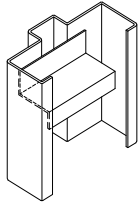

**Z-SHAPED STEEL STUD ANCHORS**  
FIGURE 8A

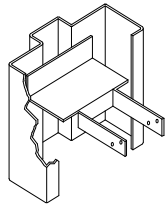

**COMBINATION WOOD OR STEEL STUD ANCHORS**  
FIGURE 8B

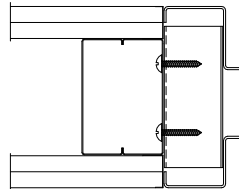

**BUTTED TO NEW STEEL STUD & GYPSUM BOARD**  
FIGURE 8C

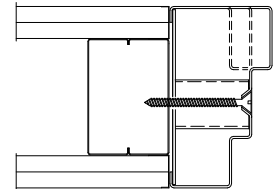

**BUTTED TO EXISTING STEEL STUD & GYPSUM BOARD**  
FIGURE 8D

For 1½ hour rated slip-on construction frames in wood or steel stud partitions Figure 9A illustrates the typical adjustable compression type *anchor* welded near the top of each jamb.

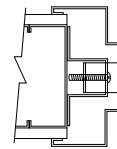

**COMPRESSION ANCHOR**  
FIGURE 9A

Figures 9B and 9C illustrate typical base *anchor* types used in conjunction with the compression *anchors* in Figure 9A. Figure 9B, the strap type, is welded or friction fitted into the bottom of each jamb face. As an alternate each face can be provided with dimpled holes as shown in Figure 9C. In both cases the bottom of the frame is secured with nails or screws through the holes in the *anchor* or jamb face into the drywall board and the wood or steel floor runner. NFPA 80 <sup>[58]</sup> requires frame installation in accordance with the instructions provided by the manufacturer for this frame construction.

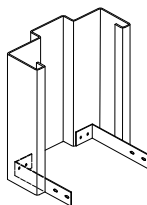

**STRAP TYPE**  
FIGURE 9B

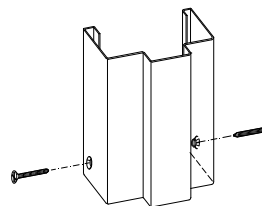

**FACE DIMPLED TYPE**  
FIGURE 9C

**Wood Stud Anchors:**

Figures 10A and 10B illustrate wood stud *anchors* which are welded to the back of the jamb and attached to the wood studs with fasteners through holes in the *anchor*. These *anchors* are eligible for use in welded and knocked-down frame product up to 1½ hour rating.

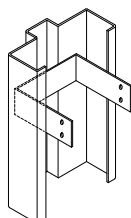

**1-PC WOOD STUD ANCHOR**  
FIGURE 10A

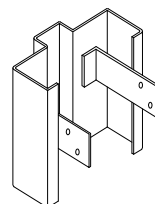

**2-PC WOOD STUD ANCHOR**  
FIGURE 10B



The *anchor* illustrated in Figure 8B can also be used for wood stud wrap applications. The anchors shown in Figure 11 can be used for end-butt in wood stud partitions. Jamb and head soffits are pierced and dimpled for ¼" (6 mm) diameter sheet metal screws not more than 6" (152 mm) from each end and at 24" (610 mm) on center maximum is also permitted for welded frame product up to 1½ hour rating. Wood screws replace the screws or expansion bolts.

**Existing Masonry Wall Anchors:**

Figure 11 illustrates existing masonry or concrete *anchor* preparations. The frame is anchored in prepared openings by means of flat head bolts and expansion shells or self-drilling concrete screws. *Anchors* of this type are located not more than 6" (152 mm) from the top and bottom of each jamb with intermediate *anchors* equally spaced at a maximum of 26" (660 mm) on center. These *anchors* are eligible for use in welded and *knocked-down* frame product up to 3 hour rating.



**EXISTING MASONRY WALL ANCHORS**

FIGURE 11

**Floor Anchors:**

Figure 12A illustrates a welded floor *anchor* and Figure 12B shows an adjustable type floor *anchor*, each for use in welded or *knocked-down* frame product. These *anchors* are welded to the inside of each jamb. Floor *anchors* are not required for two-section type frames with a pressed-steel *rough buck*, nor are they required for frames provided with existing wall *anchors*. For other applications which do not permit the use of a floor *anchor*, substitution with an additional wall *anchor* not more than 8" (204 mm) from the base of the jamb is permitted.

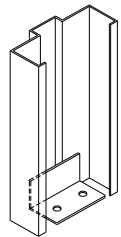

**WELDED FLOOR ANCHOR**

FIGURE 12A

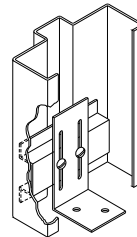

**ADJUSTABLE FLOOR ANCHOR**

FIGURE 12B

Figures 13A and 13B illustrate typical floor *anchors* provided for welded and removable *mullions*. Each is provided loose and is secured to the floor with mechanical fasteners.

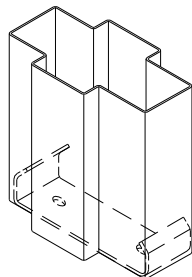

**WELDED MULLION**

FIGURE 13A

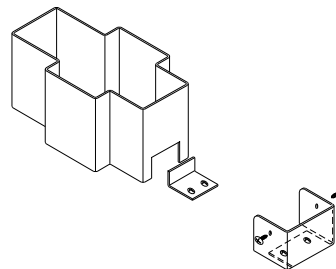

**REMOVABLE MULLION**

FIGURE 13B

## OTHER DESIGN LIMITATIONS FOR FIRE DOOR AND FRAME PRODUCT

Due to hardware limitations, code or other regulatory requirements the following are not available as *fire-protection rated* product:

- Sloped, round or arch top doors
- TRR doors in transom or sidelight frames
- Glazing materials in louvered doors
- Fire door louvers in;
  - 1/3 hr doors
  - Doors in a means of egress
  - Smoke control doors
  - Double egress doors
  - TRR doors
  - Sound control doors
  - Lead-lined doors
  - Bullet-resistant doors
- Cylindrical locks or fire exit hardware on doors exceeding 10' (3048 mm) height
- Open back strikes on pairs of 3 hour doors
- Non-labeled facings, claddings or finishes (wood veneer, plastic, paper or fabric, stone or mirrors)
- Radiused or bull-nosed lock edge doors
- Rabetted hinge edge doors
- Mail slots
- Mono rail cutouts
- Double acting doors
- Thermally broken frame product
- KD sidelights assemblies
- Slip-on transom or sidelight frames
- Doors hinged off removable vertical hollow metal mullions
- Removable vertical hollow metal mullions in 3 hour frame product
- Installations in ceilings or floors

REFERENCE AND  
SUPPORT MATERIALS

**CONTENTS**

---

|  |     |
|--|-----|
| Footnote References  |     |
| 2012 IBC .....   | 4-2 |
| NFPA 80-2010 .....   | 4-2 |
| Reference Standards .....  | 4-3 |
| Corresponding US and<br>Canadian Standards .....                 | 4-4 |
| Fire Door Labels for US and/or<br>Canadian Code Compliance ..... | 4-4 |
| Code or Standard Defined Terms .....                             | 4-5 |
| Abbreviations .....  | 4-5 |

## Footnote References

As indicated in the Foreword, on the publication date of this document, 2012 was the most recently adopted edition of the International Building Code and is the base model code reference *standard* for the information presented herein. 2010 is the NFPA 80 edition referenced in the 2012 IBC for the installation of *fire door and window assemblies*.

In order to assist readers in determining the requirements in earlier editions of the IBC and NFPA 80 (which remain in force in many jurisdictions) and future editions of either, the following lists the Chapter-Section and Title/Topics footnoted in NAAMM-HMMA 850-14. For reference purposes, the following details the edition of NFPA 80 referenced in each IBC;

|                    |      |      |      |      |      |
|--------------------|------|------|------|------|------|
| IBC Edition:       | 2000 | 2003 | 2006 | 2009 | 2012 |
| NFPA 80 Reference: | 1999 | 1999 | 1999 | 2007 | 2010 |

### IBC-2012

| Foot Note | Chapter -Section | Title or Topic   | Foot Note | Chapter -Section | Title or Topic   |
|-----------|------------------|--|-----------|------------------|--|
| 1         | 407.3.1          | Corridor Doors   | 13        | 716.3            | Opening Protectives, Marking<br>Fire-Rated Glazing Materials |
| 2         | 407.5            | Smoke Barriers   |           |                  |  |
| 3         | 408.3.8          | Interior Stairs and Ramps,<br>Glazing                  | 14        | 716.5            | Fire Door Assemblies   |
| 4         | 509.4.2          | Incidental Uses, Protection                            | 15        | 716.5.3          | Smoke Barriers, Smoke and<br>Draft Control Doors             |
| 5         | 703.6            | Fire-Resistance Rated Glazing                          | 16        | 716.5.5          | Interior Exit Stairways and Exit<br>Passageway Doors         |
| 6         | 706.8            | Fire Walls, Openings                                   |           |                  |  |
| 7         | 707.6            | Fire Barriers, Openings                                | 17        | 716.5.6          | Fire Door Frames with Transom<br>Lights and Sidelights       |
| 8         | 708.6            | Fire Partitions, Openings                              |           |                  |  |
| 9         | 709.5            | Smoke Barriers, Openings                               | 18        | 716.5.7          | Labeled Protective Assemblies                                |
| 10        | 710.3            | Smoke Partitions, Fire<br>Resistance Ratings           | 19        | 716.5.8          | Glazing Materials  |
| 11        | 710.5            | Smoke Partitions, Openings                             | 20        | 716.5.9          | Door Closing   |
| 12        | 716.2            | Opening Protectives, Fire-<br>Resistance Rated Glazing | 21        | 716.6            | Fire-Protection Rated Glazing,<br>Fire Windows               |
|           |                  |  | 22        | 1703             | Approvals  |
|           |                  |  | 23        | 2406             | Safety Glazing   |

### NFPA 80-2010

|    |         |                                  |    |           |  |
|----|---------|----------------------------------|----|-----------|--|
| 24 | 3.3.85  | Lintel (definition)              | 57 | 6.3.1.1   | Labeled Frames                             |
| 25 | 4.1.3   | Appurtenances                    | 58 | 6.3.1.4   | Slip-On Frame Installation<br>Instructions |
| 26 | 4.1.3.1 | Preparations for Hardware        |    |           |  |
| 27 | 4.2     | Labels                           | 59 | 6.3.1.7   | Clearances                                 |
| 28 | 4.2.2   | Label Location                   | 60 | 6.3.3.2   | Field Splicing                             |
| 29 | 4.3.3   | Fire Exit Hardware               | 61 | 6.3.3.3   | Glazed Frame Product - FPR                 |
| 30 | 4.3.5   | Label Text (FED)                 | 62 | 6.3.3.4   | Glazed Frame Product - FRR                 |
| 31 | 4.4.1   | Glazing - FRR or FPR             | 63 | 6.3.3.5   | Labeled Glazing                            |
| 32 | 4.4.2   | Glazing - Safety Standards       | 64 | 6.3.4.4   | Louvers in Frames                          |
| 33 | 4.4.5   | Glazing - Installation in Doors  | 65 | 6.3.5.1   | Multi-Opening Frames - Sizes               |
| 34 | 4.4.6   | Glazing - Labeling               | 66 | 6.4.1     | Closing Devices                            |
| 35 | 4.4.7   | Door Viewers                     | 67 | 6.4.1.1   | Closers                                    |
| 36 | 4.5     | Fire-Resistance Rated Glazing    | 68 | 6.4.1.2   | Coordinators                               |
| 37 | 4.6.2   | Hardware for Doors               | 69 | 6.4.3.1   | Hinges                                     |
| 38 | 4.6.3   | Builders Hardware                | 70 | 6.4.4     | Locks or Latches                           |
| 39 | 4.6.3.1 | Builders Hardware - Types        | 71 | 6.4.4.2   | Fire Exit Hardware                         |
| 40 | 4.6.3.2 | Builders Hardware - Installation | 72 | 6.4.4.3   | Active Latch Bolts                         |
| 41 | 4.6.3.3 | Fire Exit Hardware               | 73 | 6.4.4.4   | Fire Exit Hardware                         |
| 42 | 4.8.4   | Clearance                        | 74 | 6.4.4.4.1 | FEH and Open Back Strikes                  |
| 43 | 4.8.5.2 | Combustible Floor Coverings      | 75 | 6.4.4.5   | Pairs with Self-Latching Bolts             |
| 44 | 4.9     | Fire Testing                     | 76 | 6.4.4.5.1 | Pairs with Manual Bolts                    |
| 45 | 5.1.3.1 | Operability                      | 77 | 6.4.4.10  | Open Back Strikes                          |
| 46 | 5.1.5.1 | Repairs                          | 78 | 6.4.4.11  | Electric Strikes                           |
| 47 | 5.1.5.2 | Field Modifications              | 79 | 6.4.5     | Protection Plates                          |
| 48 | 5.2     | Inspections                      | 80 | 6.4.6     | Automatic Louvers                          |
| 49 | 5.2.15  | Repairs                          | 81 | 6.4.7     | Astragals                                  |
| 50 | 6.1.3   | Installation of Swinging Doors   | 82 | 6.4.8     | Gaskets                                    |
| 51 | 6.1.4   | Operation                        | 83 | 17.2.1    | Glazing Material - Labeled                 |
| 52 | 6.1.4.3 | Automatic Closing Doors          | 84 | 17.2.4    | Glazing Material - Safety Rating           |
| 53 | 6.1.4.4 | Power operated Doors             | 85 | 17.4.1    | Frame Installation                         |
| 54 | 6.2.1.1 | Frames - Non-Load Bearing        | 86 | A.6.3.1.1 | Frame Labels - Hourly Rating               |
| 55 | 6.2.1.2 | Wall Anchorage                   | 87 | A.6.4.1.1 | Self-Closing Devices                       |
| 56 | 6.2.3   | Lintels                          |    |           |  |

## Reference Standards

STANDARD TEST METHOD FOR LABORATORY MEASUREMENT OF AIRBORNE SOUND TRANSMISSION LOSS OF BUILDING PARTITIONS AND ELEMENTS, [ASTM E 90](#)

STANDARD TEST METHODS OF FIRE TESTS OF BUILDING CONSTRUCTION AND MATERIALS, [ASTM E 119](#)

CLASSIFICATION FOR RATING SOUND INSULATION, [ASTM E 413](#)

STANDARD TEST METHODS FOR HOLLOW METAL SWINGING DOOR ASSEMBLIES FOR DETENTION FACILITIES, [ASTM F 1450](#)

STANDARD TEST METHODS FOR DETENTION HOLLOW METAL VISION SYSTEMS, [ASTM F 1592](#)

American Society for Testing & Materials  
100 Barr Harbor Drive  
West Conshohocken, PA 19428-2959  
Telephone : (610) 832-9585  
E-mail : [service@astm.org](mailto:service@astm.org)  
Website : <http://www.astm.org>

BUTTS AND HINGES, [ANSI/BHMA A156.1](#)

DOOR CONTROL-CLOSERS, [ANSI/BHMA A156.4](#)

Builders Hardware Manufacturers Association  
355 Lexington Avenue  
15<sup>th</sup> Floor  
New York City, NY 10017  
Telephone : (800) 699-9277  
Website : <http://www.buildershardware.com>

### THE APPROVAL GUIDE

Factory Mutual Engineering & Research Corporation  
1151 Boston-Providence Turnpike  
Norwood, MA 02062  
Telephone : (617) 255-4682  
Website : <http://www.fmglobal.com>

### INTERNATIONAL BUILDING CODE, 2012

International Code Council  
500 New Jersey Avenue, NW  
6<sup>th</sup> Floor  
Washington, DC 20001  
Telephone : (800) 756-4452  
Website : <http://www.iccsafe.org>

### WHI (ON-LINE) DIRECTORY OF LISTED PRODUCTS

Intertek Testing Service NA, Inc.  
545 East Algonquin Road, Suite F  
Arlington Heights, IL 60005  
Telephone : (855) 944-2378  
E-mail : [BPCertHelpDesk@Intertek.com](mailto:BPCertHelpDesk@Intertek.com)  
Website : <http://www.intertek.com>

### HOLLOW METAL MANUAL

National Association of Architectural Metal Manufacturers  
800 Roosevelt Road, Building C, Suite 312  
Glen Ellyn, IL 60137  
Telephone: (630) 942-6591  
E-mail : [naamm@gss.net](mailto:naamm@gss.net)  
Website : <http://www.naamm.org>

STANDARD FOR FIRE DOORS AND OTHER OPENING PROTECTIVES, [ANSI/NFPA 80](#)

STANDARD FOR THE INSTALLATION OF SMOKE DOOR ASSEMBLIES AND OTHER OPENING PROTECTIVES, [NFPA 105](#)

STANDARD METHODS OF FIRE TESTS OF DOOR ASSEMBLIES, [ANSI/NFPA 252](#)

STANDARD ON FIRE TEST FOR WINDOW AND GLASS BLOCK ASSEMBLIES, [ANSI/NFPA 257](#)

National Fire Protection Association  
One Batterymarch Park  
P.O. Box 9101  
Quincy, MA 02269-9101  
Telephone : (617) 770-3000  
E-mail : [custserv@nfpa.org](mailto:custserv@nfpa.org)  
Website : <http://www.nfpa.org>

STANDARD FOR FIRE TESTS OF WINDOW ASSEMBLIES, [ANSI/UL 9](#)

STANDARD FOR POSITIVE PRESSURE FIRE TESTS OF DOOR ASSEMBLIES, [ANSI/UL 10C](#)

OUTLINE OF INVESTIGATION FOR FIRE DOOR FRAMES, [UL 63](#)

STANDARD FOR FIRE TESTS OF BUILDING CONSTRUCTION AND MATERIALS, [ANSI/UL 263](#)

STANDARD FOR BULLET-RESISTING EQUIPMENT, [ANSI/UL 752](#)

STANDARD FOR AIR LEAKAGE TESTS OF DOOR ASSEMBLIES, [ANSI/UL 1784](#)

### UL (ON-LINE) FIRE RESISTANCE DIRECTORY

UL, LLC  
333 Pfingsten Road  
Northbrook, IL 60612  
Telephone : (847) 272-8800  
E-mail : [cec.us@us.ul.com](mailto:cec.us@us.ul.com)  
Website : <http://www.ul.com>

SAFETY STANDARD FOR ARCHITECTURAL GLAZING MATERIALS, [CPSC 16 CFR 1201](#)

US Government Bookstore  
National Archives and Records Administration  
Office of the Federal Register  
710 North Capitol Street N.W.  
Washington, DC  
Telephone : (800) 512-1800  
Website : <http://www.bookstore.gpo.gov>

## Corresponding US and Canadian Standards

Many HMMA member manufacturers provide *fire-protection rated* products for both the US and Canadian markets. Although the fire tests are similar they are not identical. Compliance with one country's *standards* does not necessarily provide approval within the other.

The Canadian model code, the National Building Code of Canada (NBCC), mandates neutral pressure protocols, hose stream testing of all *fire-protection rated* components, is both performance and objective based and the "pass/fail" criteria for *fire door assemblies* differ slightly. The NBCC is more restrictive with respect to exclusions when active protection systems are utilized.

As stated in the Foreword the scope of this manual is limited to the requirements in the United States. However, for reference purposes, Table 6 provides the corresponding US and Canadian code mandated fire test and related *standards*.

| Standard                                   | United States                        | Canada                                  |
|--|--------------------------------------|---|
| Model Building Code                        | International Building Code - 2012   | National Building Code of Canada - 2010 |
| Fire Door Assembly Tests                   | ANSI/UL 10C-09 or ANSI/NFPA 252-2008 | CAN/ULC-S104-10                         |
| Fire Door Frame and Transom Frame Design   | UL Subject 63-03                     | CAN/ULC-S105-09                         |
| Fire Window Assembly Tests                 | ANSI/UL 9-09 or ANSI/NFPA 257-2007   | CAN4-S106-M80(R1985)                    |
| Fire Door and Window Assembly Installation | ANSI/NFPA 80-2010                    | ANSI/NFPA-80-2007                       |
| Smoke Control Tests                        | ANSI/UL 1784-01                      | Not Applicable                          |
| Smoke Control Assembly Installation        | ANSI/NFPA 105-2010                   | Not Applicable                          |
| Wall Assembly Fire Tests                   | ANSI/UL 263-11 or ASTM E119-12       | CAN/ULC-S101-07                         |
| Safety Glazing Tests                       | CPSC 16 CFR 1201                     | Not Applicable                          |

CORRESPONDING US AND CANADIAN STANDARDS

TABLE 6

### Fire Door Labels for US and/or Canadian Code Compliance

UL and WHI/ITS test, certify and *list fire-protection rated* products to the fire test *standards* of both countries. To identify such products they have adopted similar *marking* systems. The Figures below illustrate the basic *fire door label* content to indicate compliance with various UL and/or Canadian code requirements.

- To show compliance with US positive pressure (UL 10C), US (legacy) neutral pressure (UL 10B) and the Canadian (S104) code requirements the *label* must include "UL 10C", a "cXXus" logo, reference to "Installation Instructions" and "Temp Rise Rating", as in Figure 12.
- For US neutral pressure compliance only (UL 10B) the *label* will not include any reference to "UL 10C" or a "cXXus" logo as shown in Figure 13. The "S" symbol, "Installation Instructions" and "Temp Rise Exceeds" are not required but may be included.
- When compliant with the US neutral pressure (UL 10B) and the Canadian (S104) code requirements only the *label* will have a "cXXus" logo without a reference to "UL 10C", as in Figure 14. The "S" symbol, "Installation Instructions" and "Temp Rise Exceeds" references are not required but may be included.
- For product compliant with the Canadian (S104) requirements only a "cXX" logo will be present as in Figure 15. There will be no reference to "UL 10C". The "S" symbol, "Installation Instructions" and "Temp Rise Exceeds" are not required.



FIGURE 12  
(Ref Item 1)

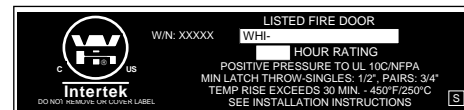

FIGURE 13  
(Ref Item 2)



FIGURE 14  
(Ref Item 3)



FIGURE 15  
(Ref Item 4)



## Code or Standard Defined Terms

The following terms are defined in ANSI/NAMM [HMMA 801](#), the 2012 [IBC](#) and/or [NFPA 80-2010](#), appear in *italics* within this manual and are used in the context defined in the first *standard* referenced.

| <u>Term</u>                         | <u>Defined In</u> | <u>Term</u>                          | <u>Defined In</u> |
|-------------------------------------|-------------------|--------------------------------------|-------------------|
| Active Leaf .....                   | 801, NFPA         | Hollow Metal (Frame) .....           | 801, NFPA         |
| Anchor .....                        | 801, NFPA         | Inactive Leaf .....                  | 801, NFPA         |
| Approved .....                      | IBC, NFPA         | Interior Exit Ramp .....             | IBC               |
| Astragal .....                      | 801, NFPA         | Interior Exit Stairway .....         | IBC               |
| Authority Having Jurisdiction ..... | NFPA              | Knocked-Down (KD) Frame .....        | 801, NFPA         |
| Automatic / Automatically .....     | IBC, NFPA         | Label .....                          | IBC               |
| Classified .....                    | 801, NFPA         | Labeled .....                        | 801, IBC, NFPA    |
| Coordinator .....                   | NFPA              | Listed .....                         | IBC, NFPA         |
| Corridor .....                      | IBC               | Mark .....                           | IBC               |
| Double Egress .....                 | 801, NFPA         | Means of Egress .....                | IBC               |
| Door Closer .....                   | NFPA              | Mullion .....                        | 801, NFPA         |
| Door Protection Plate .....         | NFPA              | Multiple Opening (Door) Frame .....  | NFPA              |
| Dutch Door .....                    | 801, NFPA         | Occupant Load .....                  | IBC               |
| Electric Strike .....               | NFPA              | Panic Hardware .....                 | IBC               |
| Exit .....                          | IBC               | Plant-On .....                       | NFPA              |
| Exit Access .....                   | IBC               | Rough Buck .....                     | 801, NFPA         |
| Exit Access Doorway .....           | IBC               | Self-Closing (Door or Device) .....  | IBC, NFPA         |
| Exit Access Ramp .....              | IBC               | Self-Latching (Bolt or Device) ..... | NFPA              |
| Exit Access Stairway .....          | IBC               | Shaft Enclosure .....                | IBC               |
| Exit Passageway .....               | IBC               | Sidelight Frame .....                | 801, NFPA         |
| Fire Barrier .....                  | IBC               | Single-Point Latch .....             | NFPA              |
| Fire Door .....                     | IBC, NFPA         | Smoke Barrier .....                  | IBC               |
| Fire Door Assembly .....            | IBC, NFPA         | Spring Hinge .....                   | NFPA              |
| Fire Door Frame (Product) .....     | NFPA              | Stairway .....                       | IBC               |
| Fire Door Hardware .....            | NFPA              | Standard .....                       | NFPA              |
| Fire Exit Hardware .....            | IBC, NFPA         | Strike (Plate) .....                 | NFPA              |
| Fire Partition .....                | IBC               | Transom (Opening) .....              | 801, NFPA         |
| Fire-Protection Rating .....        | 801, IBC, NFPA    | Transom (and Side Panel) Frame ..... | NFPA              |
| Fire-Rated Glazing .....            | IBC               | Transom (and Sidelight) Frame .....  | NFPA              |
| Fire-Resistance .....               | IBC               | Transom (Light) Frame .....          | NFPA              |
| Fire-Resistance Rating .....        | IBC, NFPA         | Transom Panel .....                  | NFPA              |
| Fire Wall .....                     | IBC               | Transom (Panel) Frame .....          | NFPA              |
| Fire Window Assembly .....          | IBC, NFPA         | Viewer .....                         | NFPA              |
| Flush Bolts .....                   | NFPA              | Window (Frame) .....                 | NFPA              |
| Glazing Material .....              | 801, NFPA         | Wired Glass .....                    | NFPA              |

## Abbreviations

|            |  |             |  |
|------------|--|-------------|--|
| AHJ .....  | Authority Having Jurisdiction  | ICC .....   | International Code Council                                   |
| ANSI ..... | American National Standards Institute                                    | ISO .....   | International Standards Organization                         |
| ASTM ..... | American Society for Testing and Materials                               | ITS .....   | Intertek Testing Services                                    |
| BSI .....  | British Standards Institute  | KD .....    | Knock (or Knocked)-Down                                      |
| DIN .....  | Deutsches Institut für Normung<br>(German Institute for Standardization) | KD-DW ..... | Knock (or Knocked)-Down Drywall                              |
| FAM .....  | Factory Audit Manual   | LOC .....   | Letter of Certification                                      |
| FED .....  | Fire Exit Device   | NAAMM ..... | National Association of Architectural<br>Metal Manufacturers |
| FEH .....  | Fire Exit Hardware   | NBCC .....  | National Building Code of Canada                             |
| FM .....   | Factory Mutual   | NFPA .....  | National Fire Protection Association                         |
| FPR .....  | Fire-Protection Rated (or Rating)  | SGCC .....  | Safety Glazing Certification Council                         |
| FRR .....  | Fire-Resistance Rated (or Rating)  | STC .....   | Sound Transmission Class                                     |
| FUS .....  | Follow-Up Service  | TRR .....   | Temperature-Rise Rated (or Rating)                           |
| HIR .....  | Human Impact Resistance (or Resistant)                                   | UL .....    | Underwriters Laboratories                                    |
| HMMA ..... | Hollow Metal Manufacturers Association                                   | WHI .....   | Warnock Hersey Inc.  |
| IBC .....  | International Building Code  |             |  |

## RECOMMENDED GUIDE SPECIFICATIONS FOR HMMA HOLLOW METAL DOORS AND FRAMES

- ANSI/NAAMM  
HMMA 860** - Hollow Metal Doors and Frames
- ANSI/NAAMM  
HMMA 861** - Commercial Hollow Metal Doors and Frames
- ANSI/NAAMM  
HMMA 862** - Commercial Security Hollow Metal Doors and Frames
- ANSI/NAAMM  
HMMA 863** - Detention Security Hollow Metal Doors and Frames
- ANSI/NAAMM  
HMMA 865** - Swinging Sound Control Hollow Metal Door and Frame Assemblies
- ANSI/NAAMM  
HMMA 866** - Stainless Steel Hollow Metal Doors and Frames
- ANSI/NAAMM  
HMMA 867** - Commercial Laminated Core Hollow Metal Doors and Frames

## RELATED HMMA DOCUMENTS

- HMMA 800** - Introduction to Custom Hollow Metal
- ANSI/NAAMM  
HMMA 801** - Glossary of Terms for Hollow Metal Doors and Frames
- HMMA 802** - Manufacturing of Hollow Metal Doors and Frames
- HMMA 803** - Steel Tables
- HMMA 804** - Quality Control Template for Hollow Metal Door and Frame Manufacturers
- HMMA 805** - Recommended Selection and Usage Guide for Hollow Metal Doors and Frames
- HMMA 810** - Hollow Metal Doors
- HMMA 820** - Hollow Metal Frames
- HMMA 830** - Hardware Selection for Hollow Metal Doors and Frames
- HMMA 831** - Hardware Locations for Hollow Metal Doors and Frames
- HMMA 840** - Guide Specification for Installation and Storage of Hollow Metal Doors and Frames
- ANSI/NAAMM  
HMMA 841** - Tolerances and Clearances for Commercial Hollow Metal Doors and Frames
- HMMA 850** - Fire-Protection and Smoke Control Rated Hollow Metal Door and Frame Products
- HMMA 890** - Technical Summary
- HMMA 810-TN01** - Defining Undercuts
- HMMA 820-TN01** - Grouting Hollow Metal Frames
- HMMA 820-TN02** - Continuously Welded Frames
- HMMA 820-TN03** - Guidelines for Glazing of Hollow Metal Transoms, Sidelights and Windows
- HMMA 840-TN01** - Painting Hollow Metal Products
- HMMA 840-TN02** - Maintenance of Installed Hollow Metal Products